

**N-0311 - Retrete Tomelloso**  
**N Scale (1:160)**



Component parts

Assembly instructions

Main dimensions

# N-0311 Retrete Tomelloso. Component parts

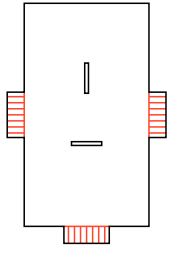

01

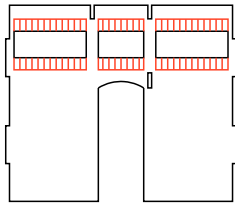

02

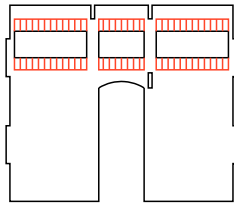

02

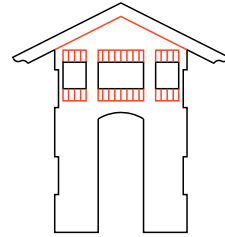

03

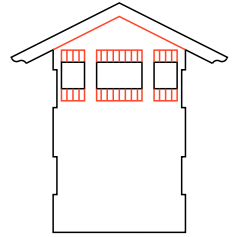

04

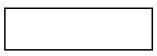

05

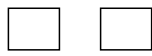

06 x2

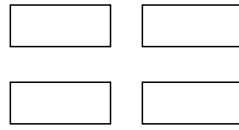

07 x4

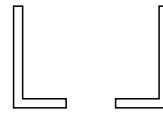

08 x2



09

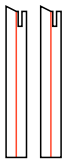

10 x2



11 x2

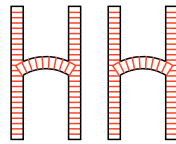

12 x2

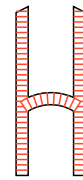

13

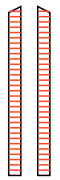

18 x2

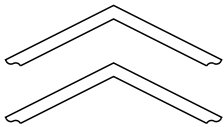

19 x2

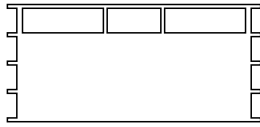

20

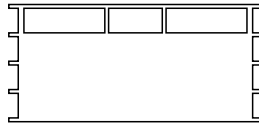

20

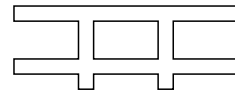

21

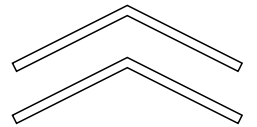

22 x2

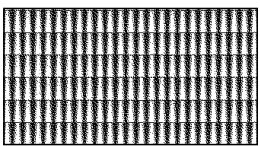

23

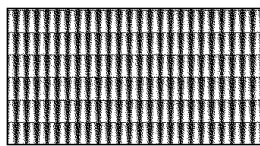

23

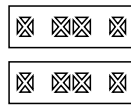

24 x2

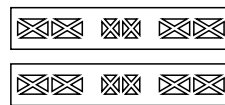

25 x2

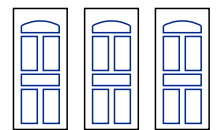

26 x3

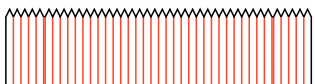

27

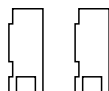

28 x2

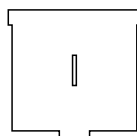

29

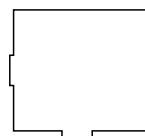

30

# N-0311 Retrete Tomelloso. Assembly instructions

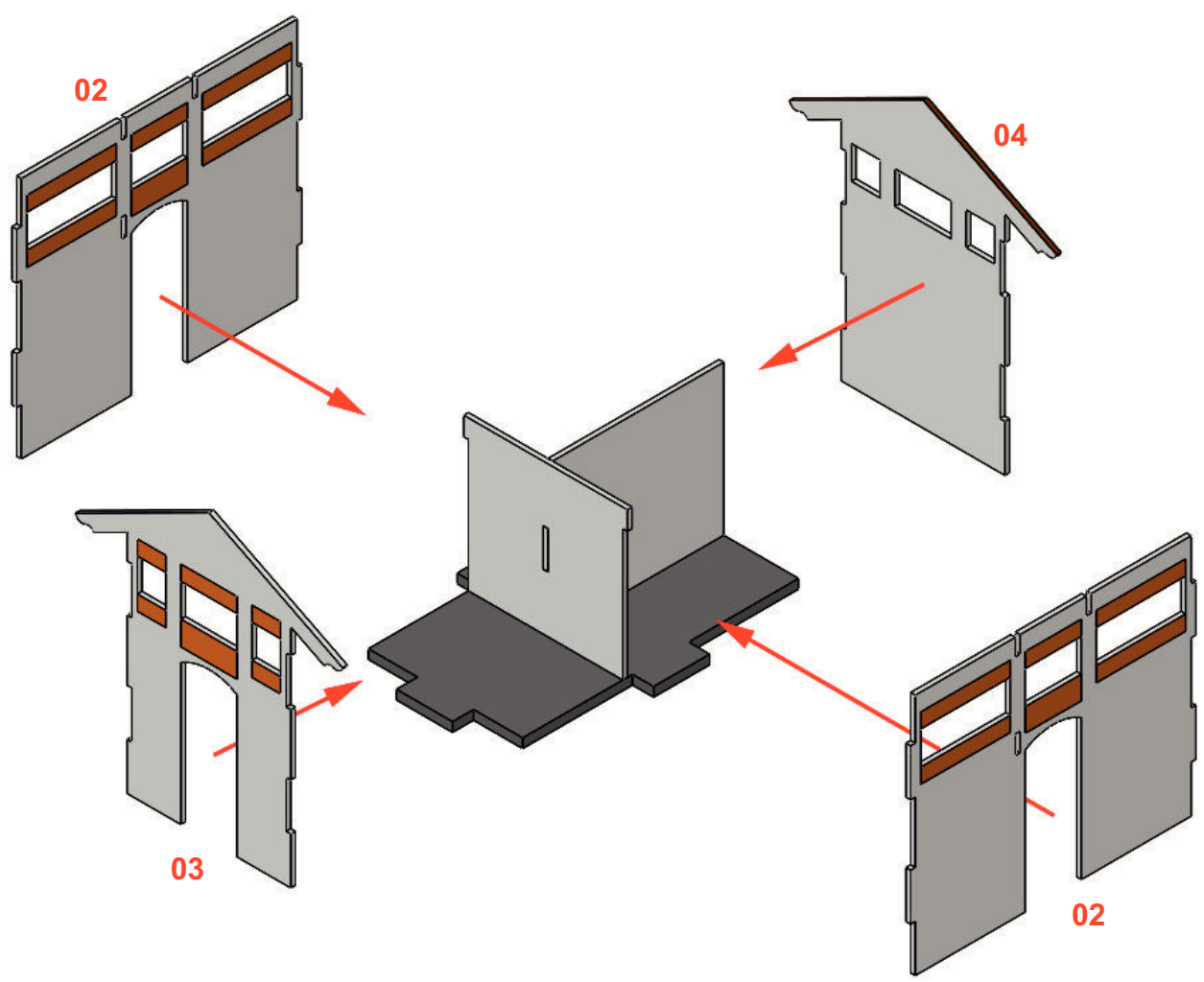
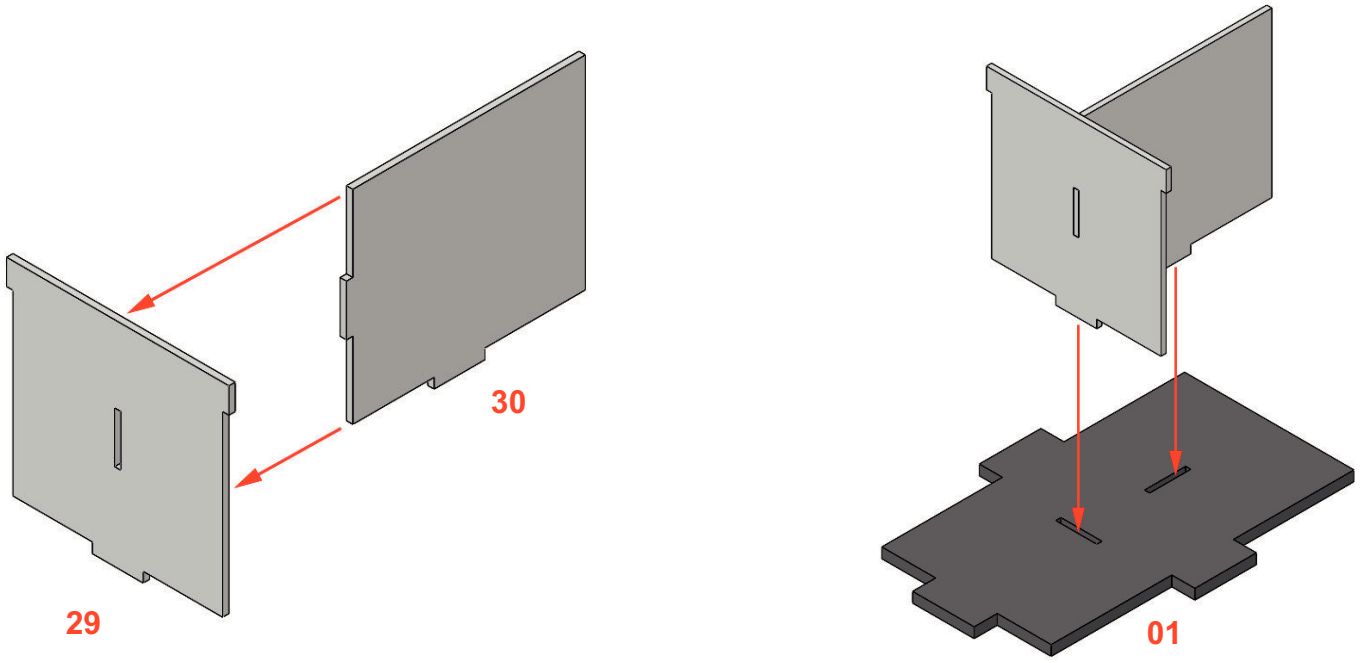

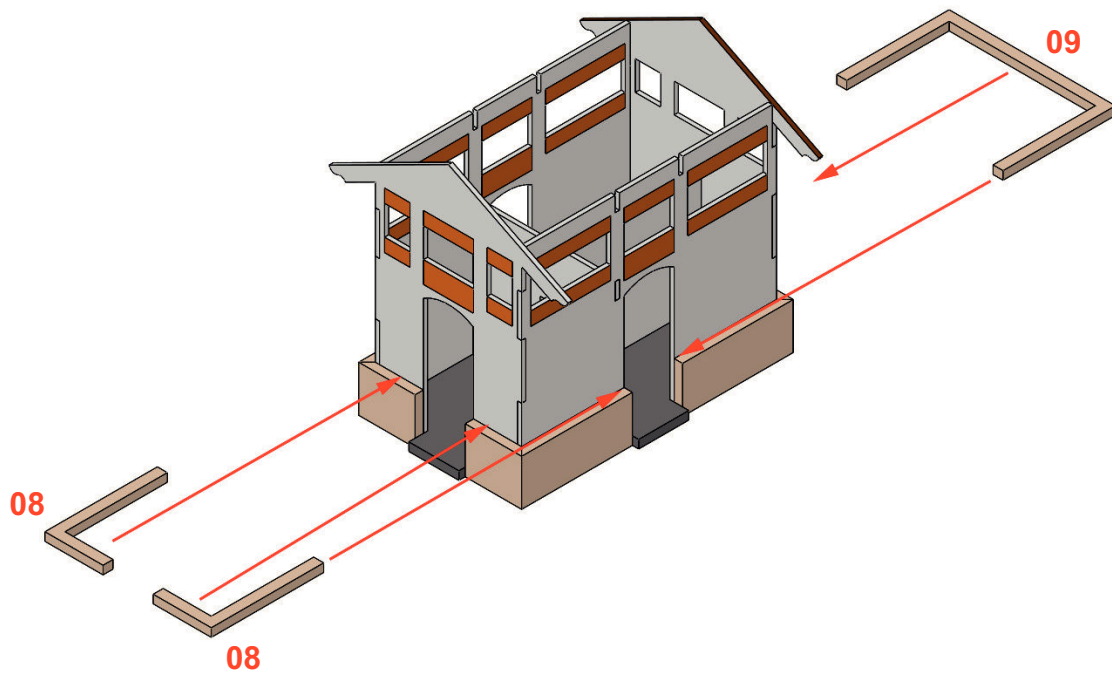
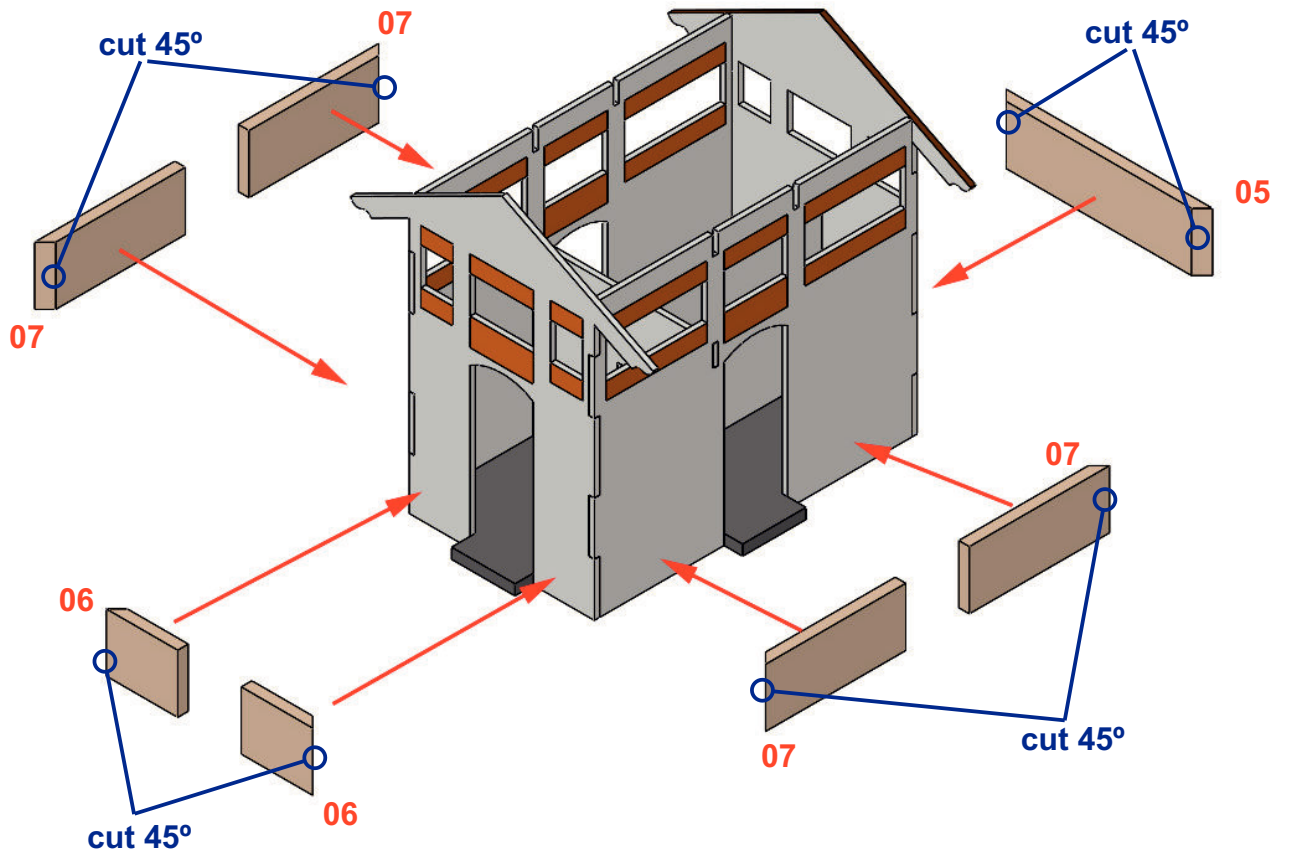

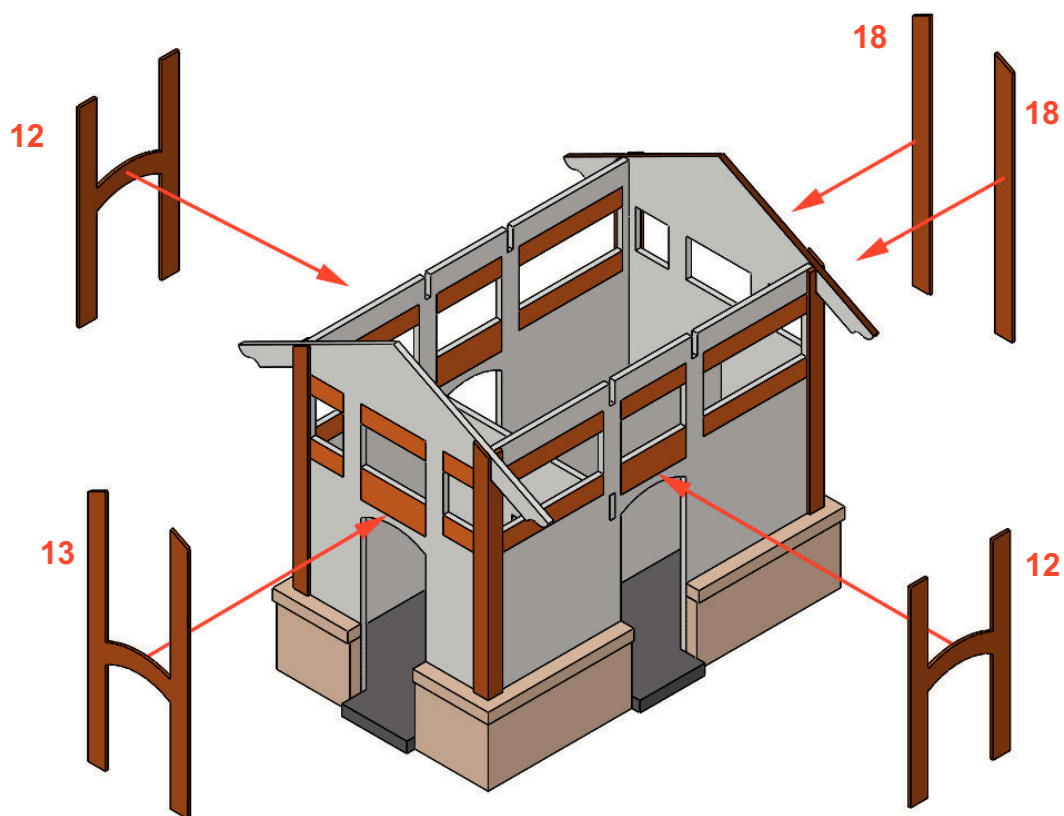
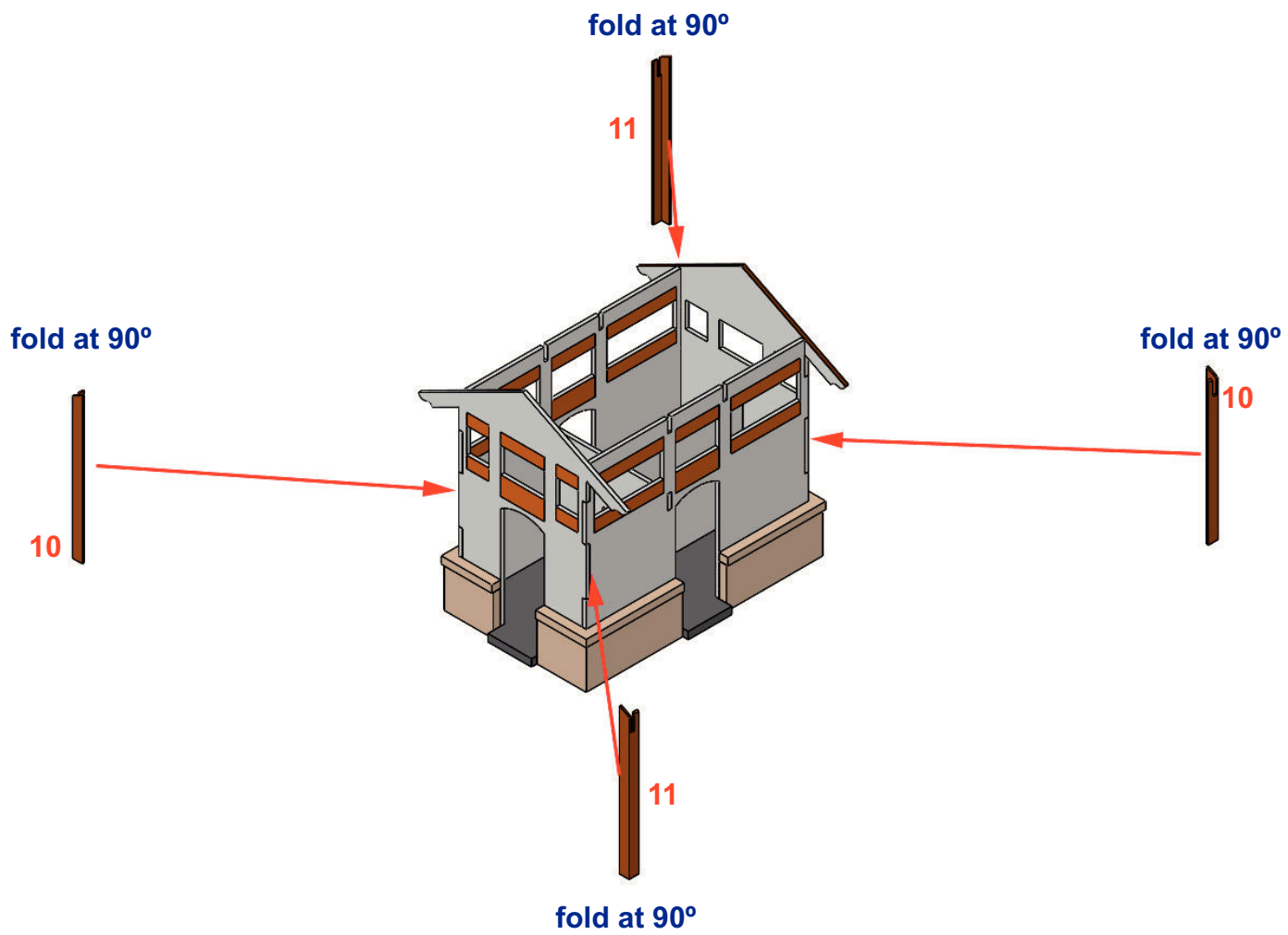

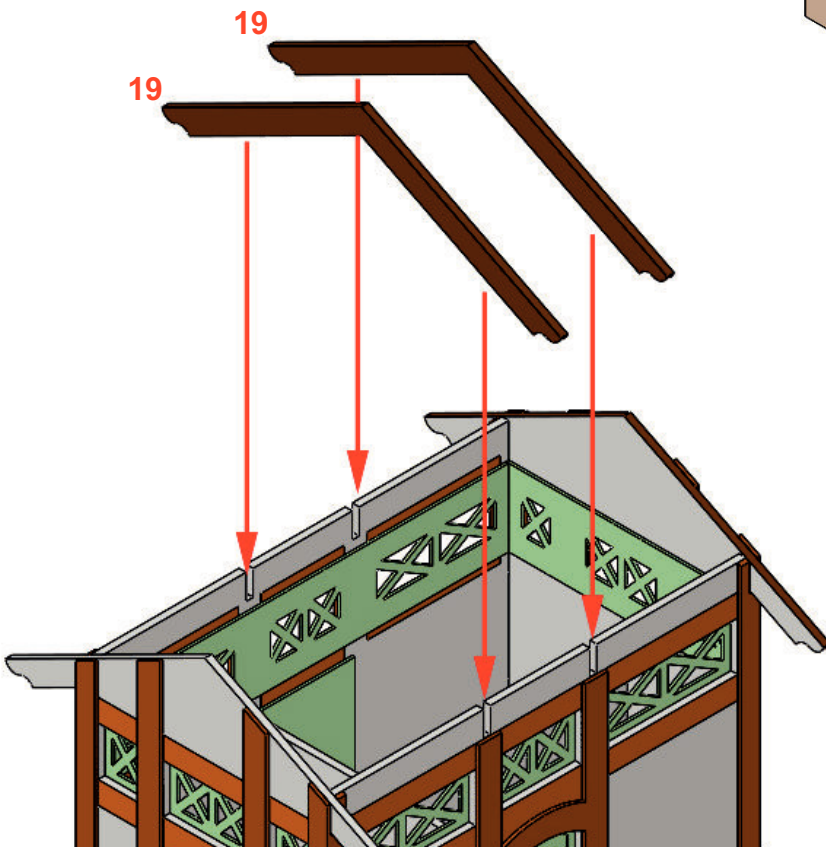
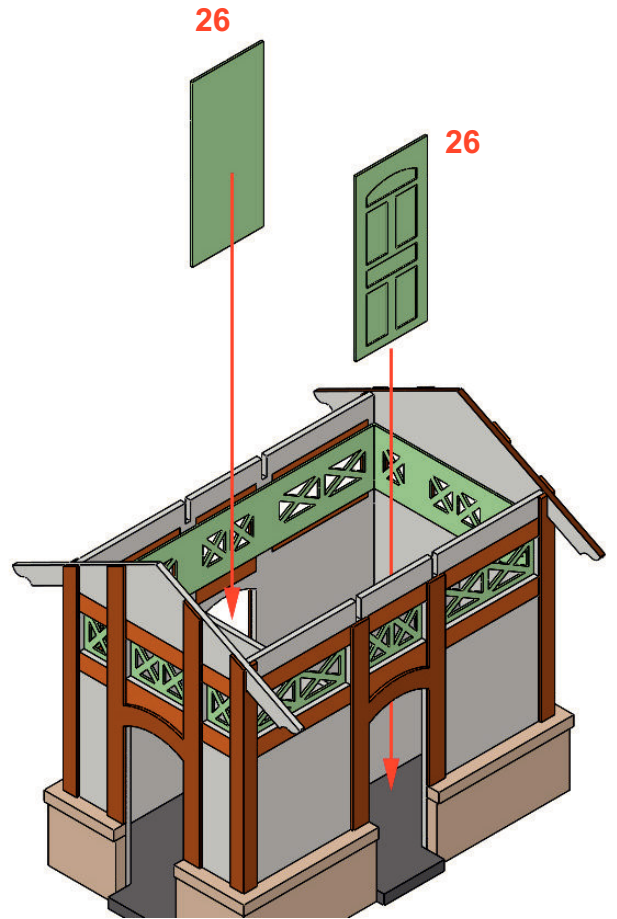
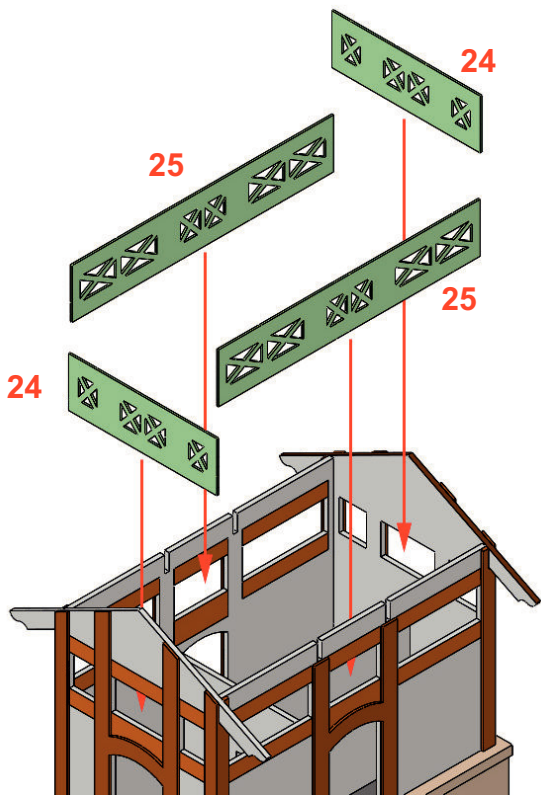

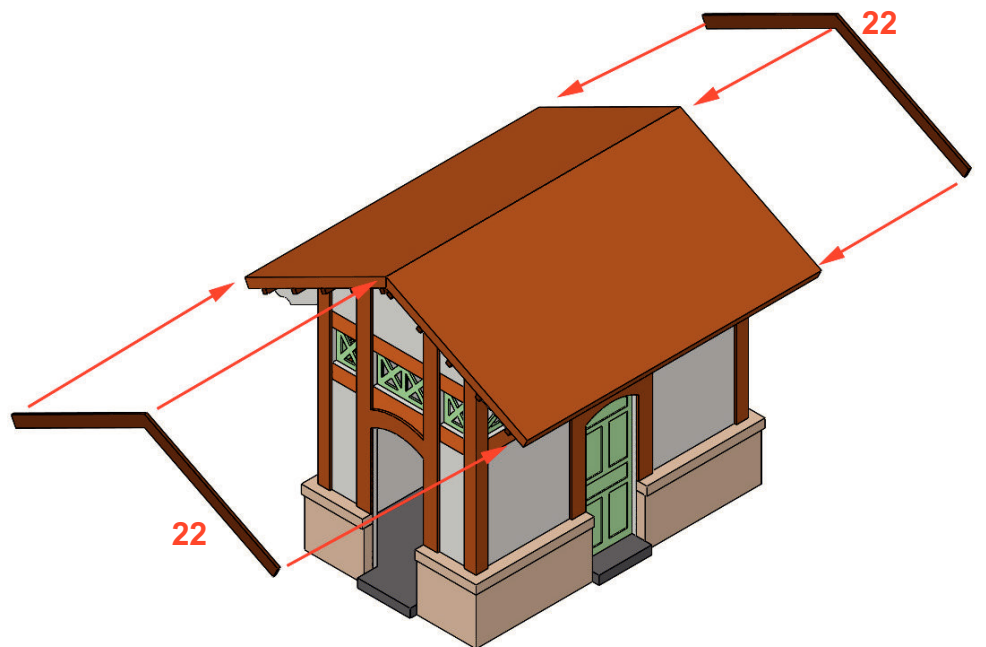
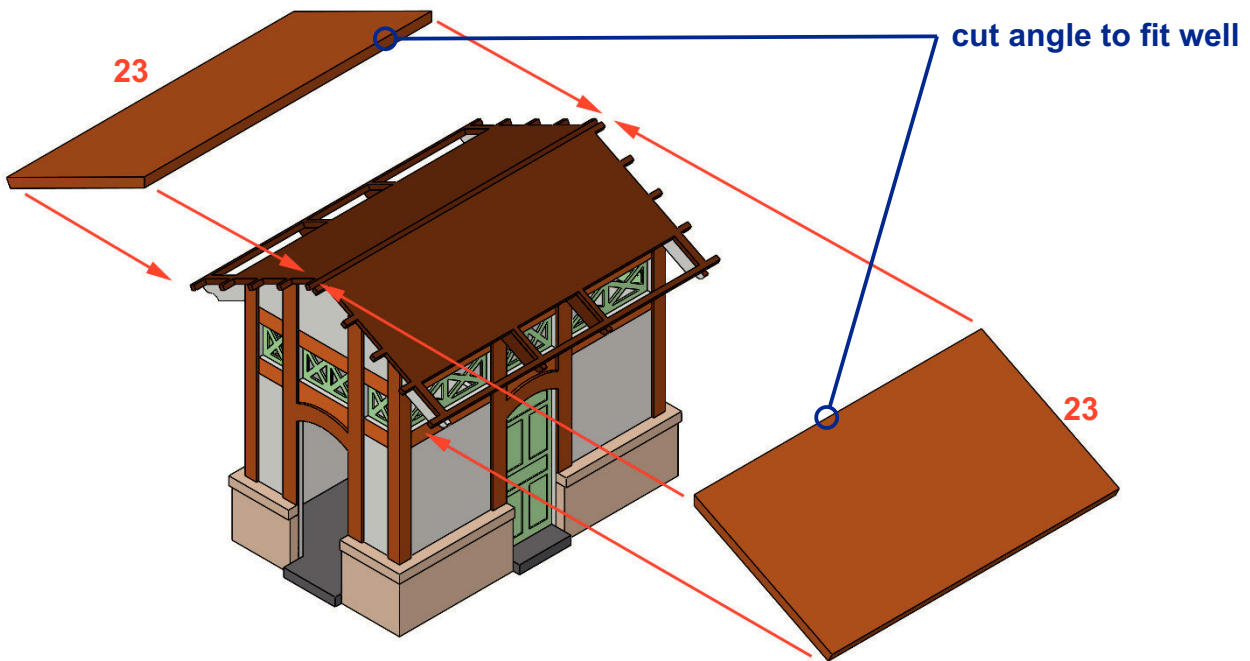
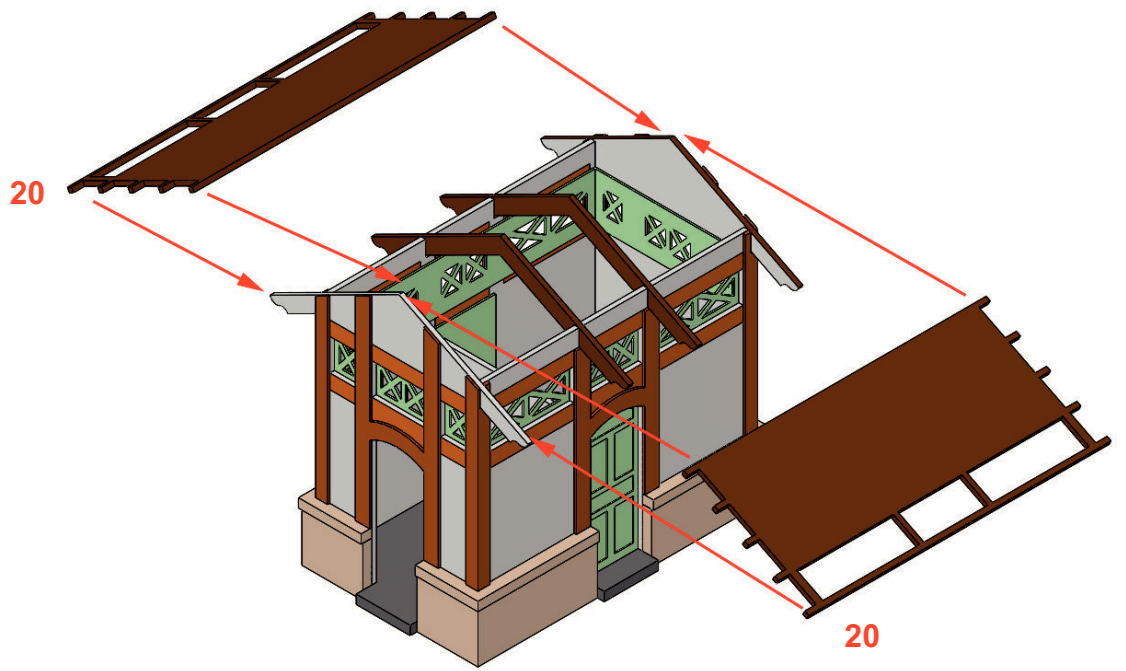

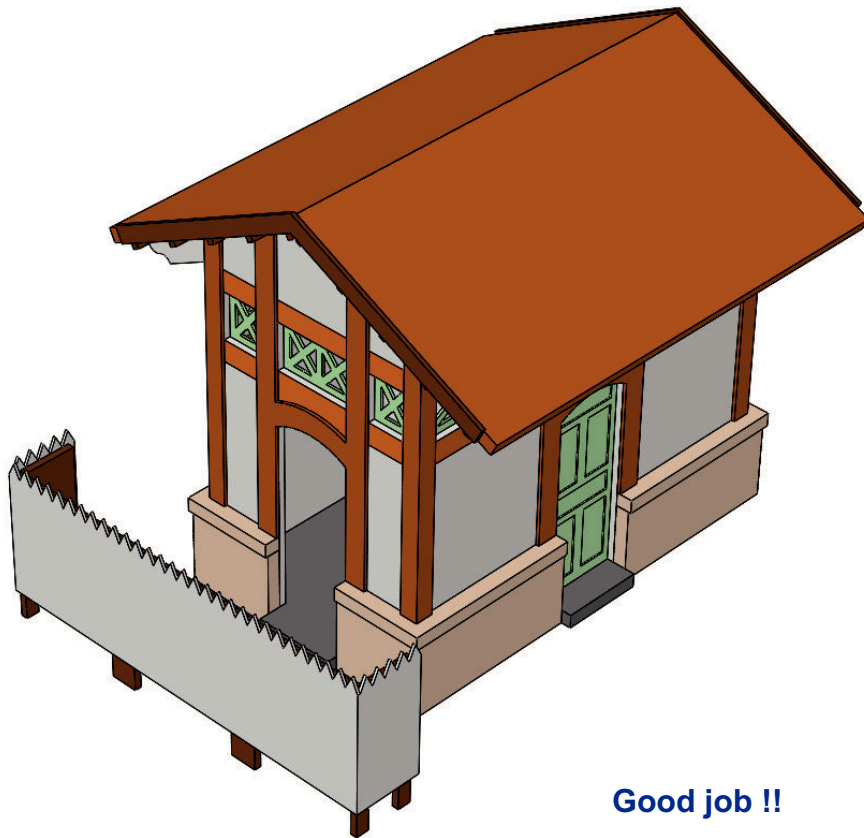
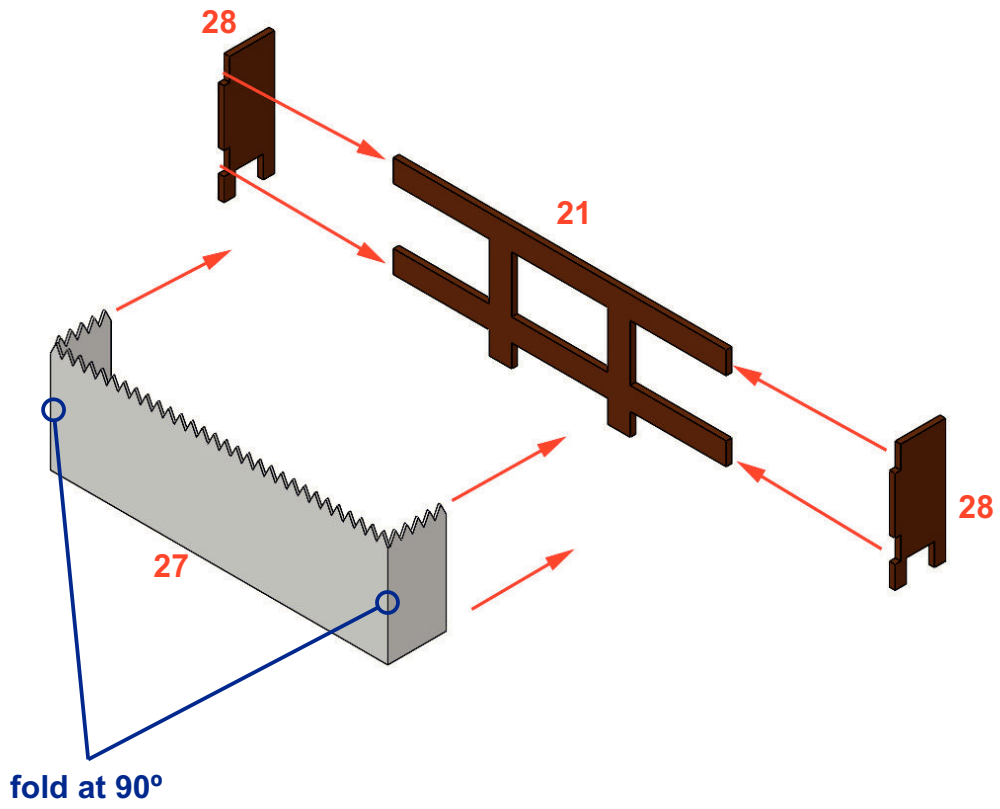

Good job !!



**N-0311 Retrete Tomelloso. Main dimensions**

