

## N-0121 Estación de Valsequillo escala N



Despiece  
Manual de montaje  
Planos

# N0121 Estación de Valsequillo - escala N

## Despiece

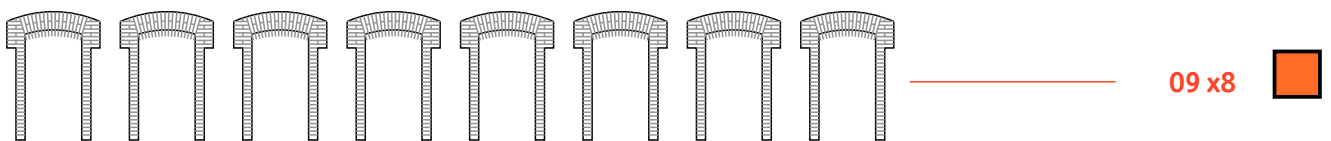
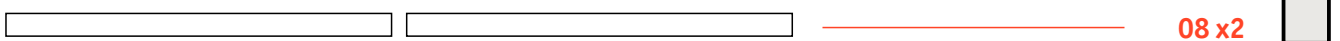
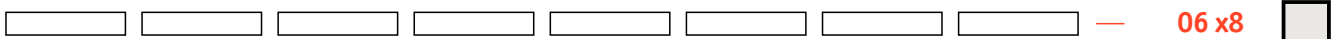
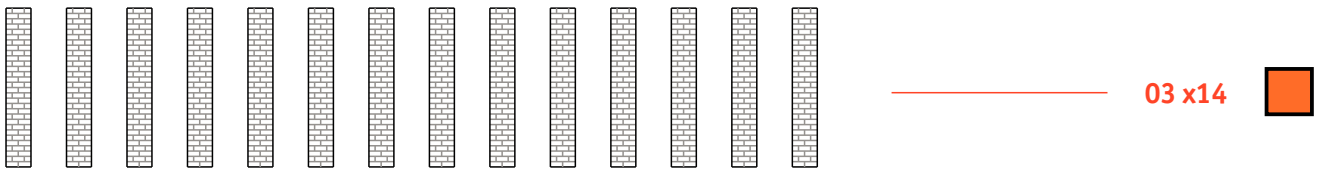
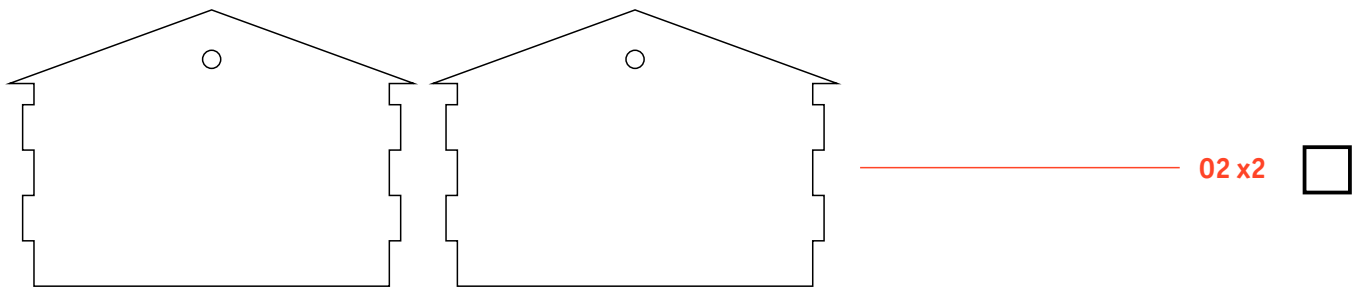
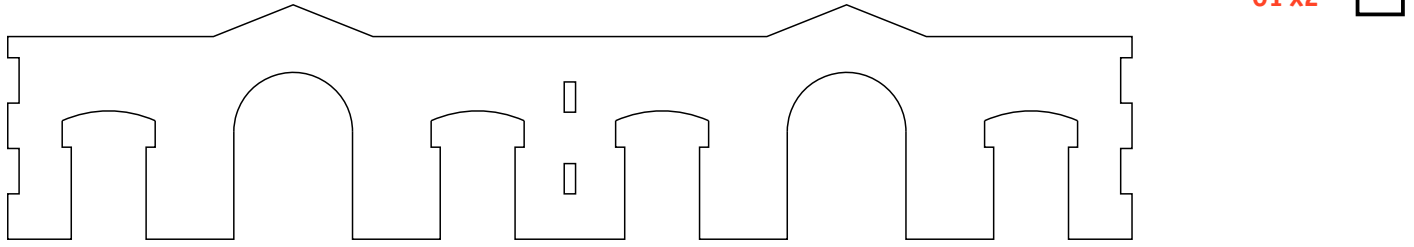
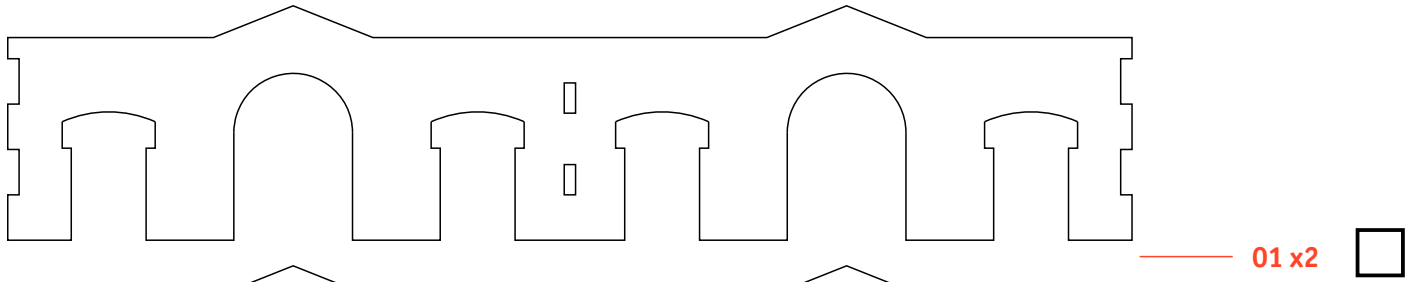

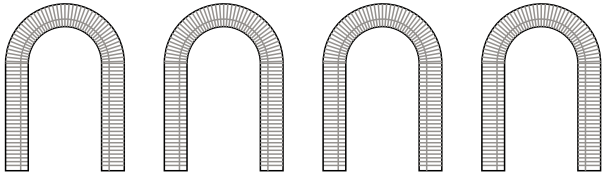

11 x4

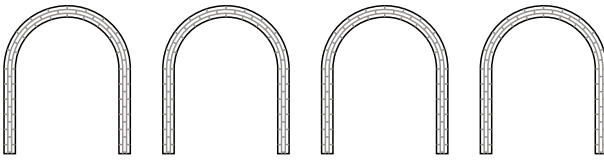

12 x4

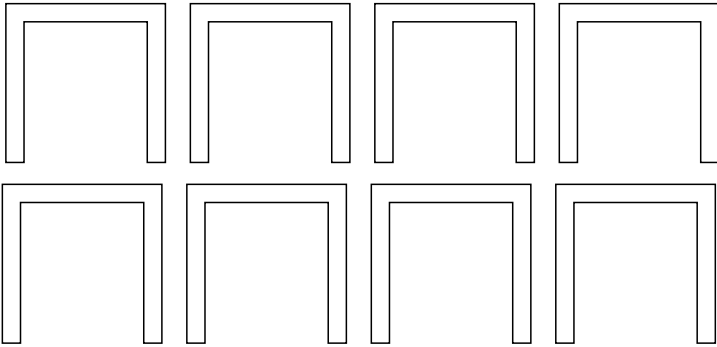

13 x8

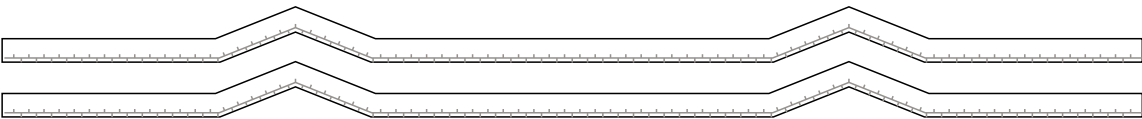

14 x2



15 x2



16 x2

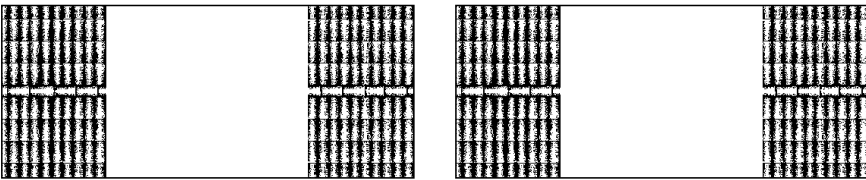

17 x2



18 x2



19 x2

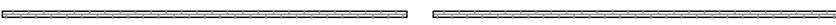

20 x2



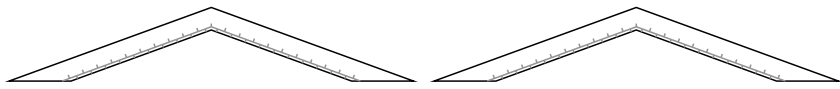

21 x2

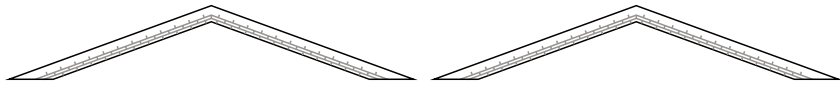

22 x2



23 x2

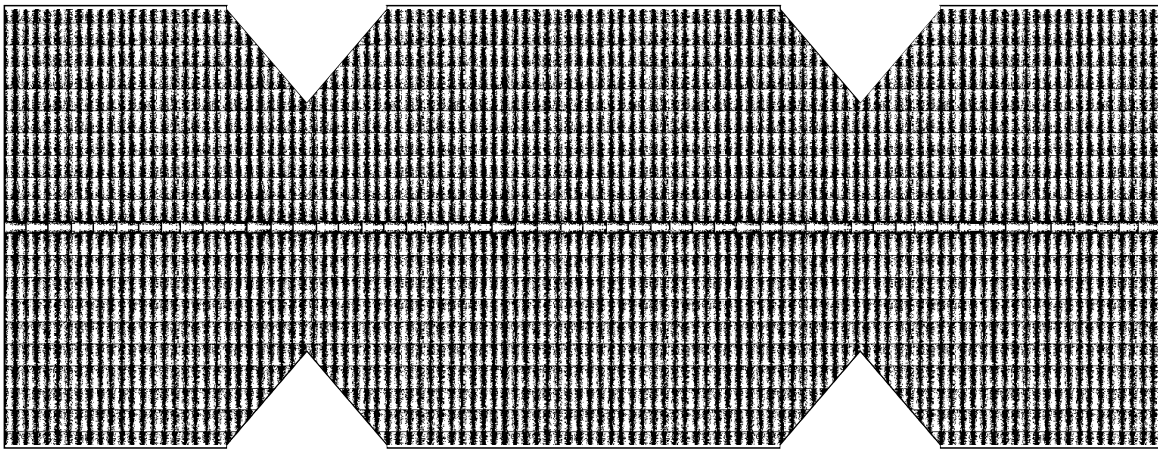

24



25 x2



26 x2

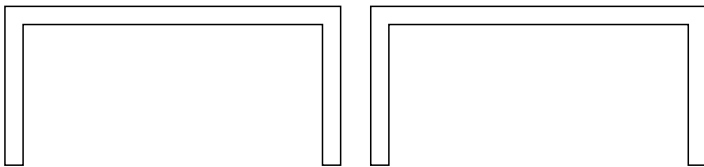

27 x2

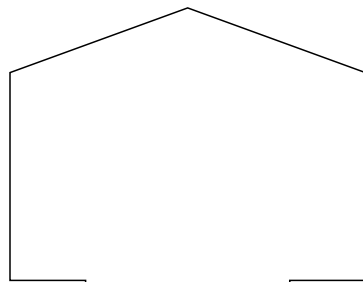

28

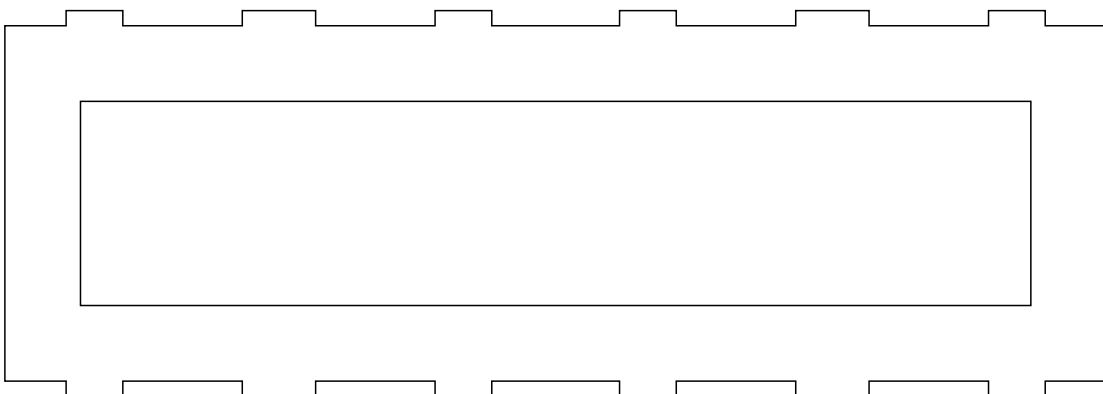

29



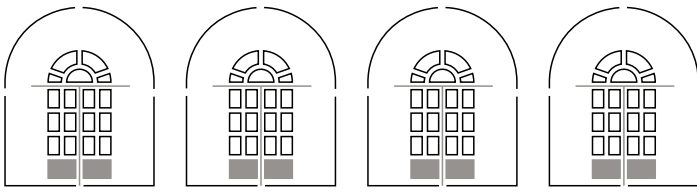

30 x4

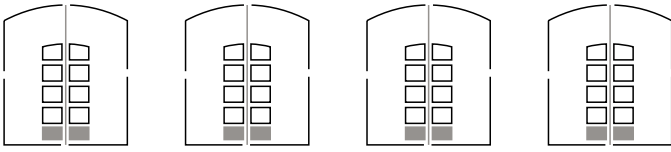

31 x8

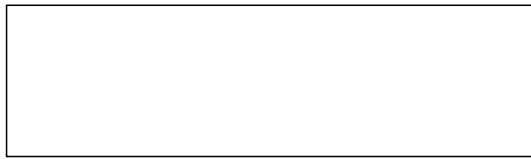
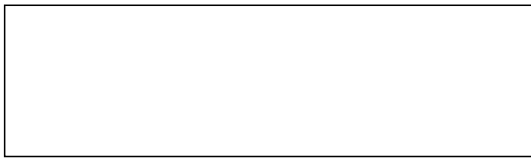
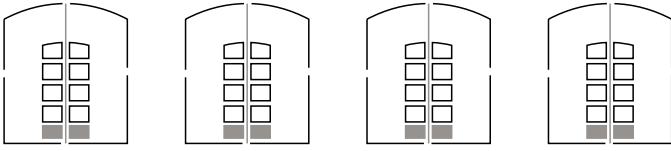

32 x4



# N0121 Estación de Valsequillo - escala N

## Pintura

Para pintar la estación al completo sólo se utilizan 4 colores, a saber:

- blanco
- gris claro
- gris medio / perla
- naranja / ladrillo

Todos los colores están indicados en el despiece. Las piezas marcadas con ☒ no deben pintarse, o bien porque están ocultas o bien porque se trata de acetato transparente (cristales)

Debe pintar todas las piezas antes de ensamblar la estación, aunque es preferible ensamblar los tres conjuntos siguientes antes de pintar:

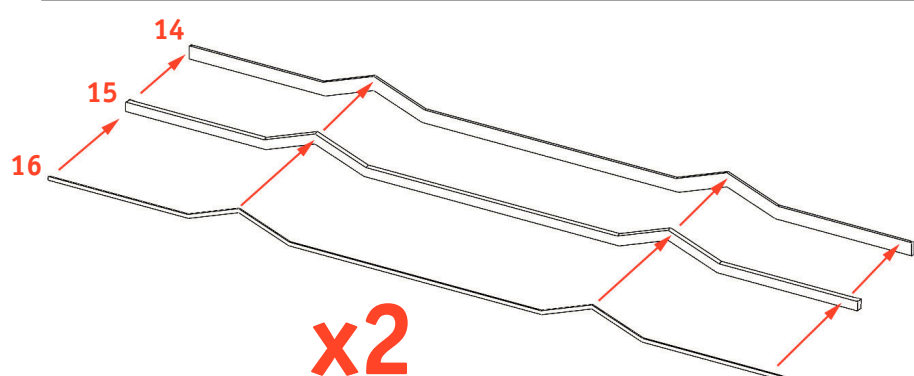

Ensamblar 2 unidades de este conjunto antes de pintar.  
Encajar las piezas por la parte superior y utilizar como referencia los dos picos.  
La pieza 16 es mas larga que la 14 ya que luego realizará un inglete en las puntas.

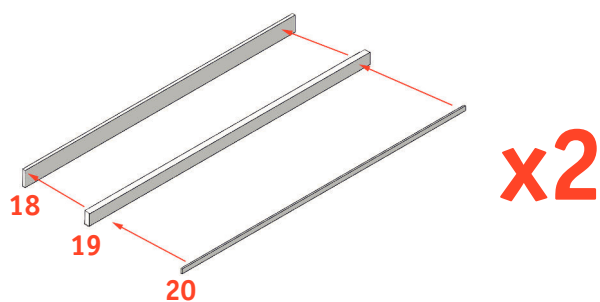

Ensamblar 2 unidades de este conjunto antes de pintar.  
Encajar las piezas por la parte superior y centradas.  
La pieza 20 es mas larga que la 18 ya que luego realizará un inglete en las puntas.

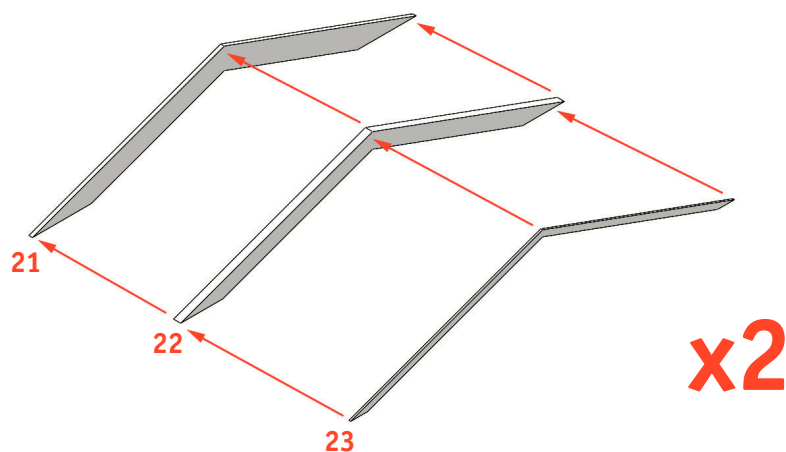

Ensamblar 2 unidades de este conjunto antes de pintar.  
Encajar las piezas por la parte superior y centradas.

# N0121 Estación de Valsequillo - escala N

## Manual de montaje

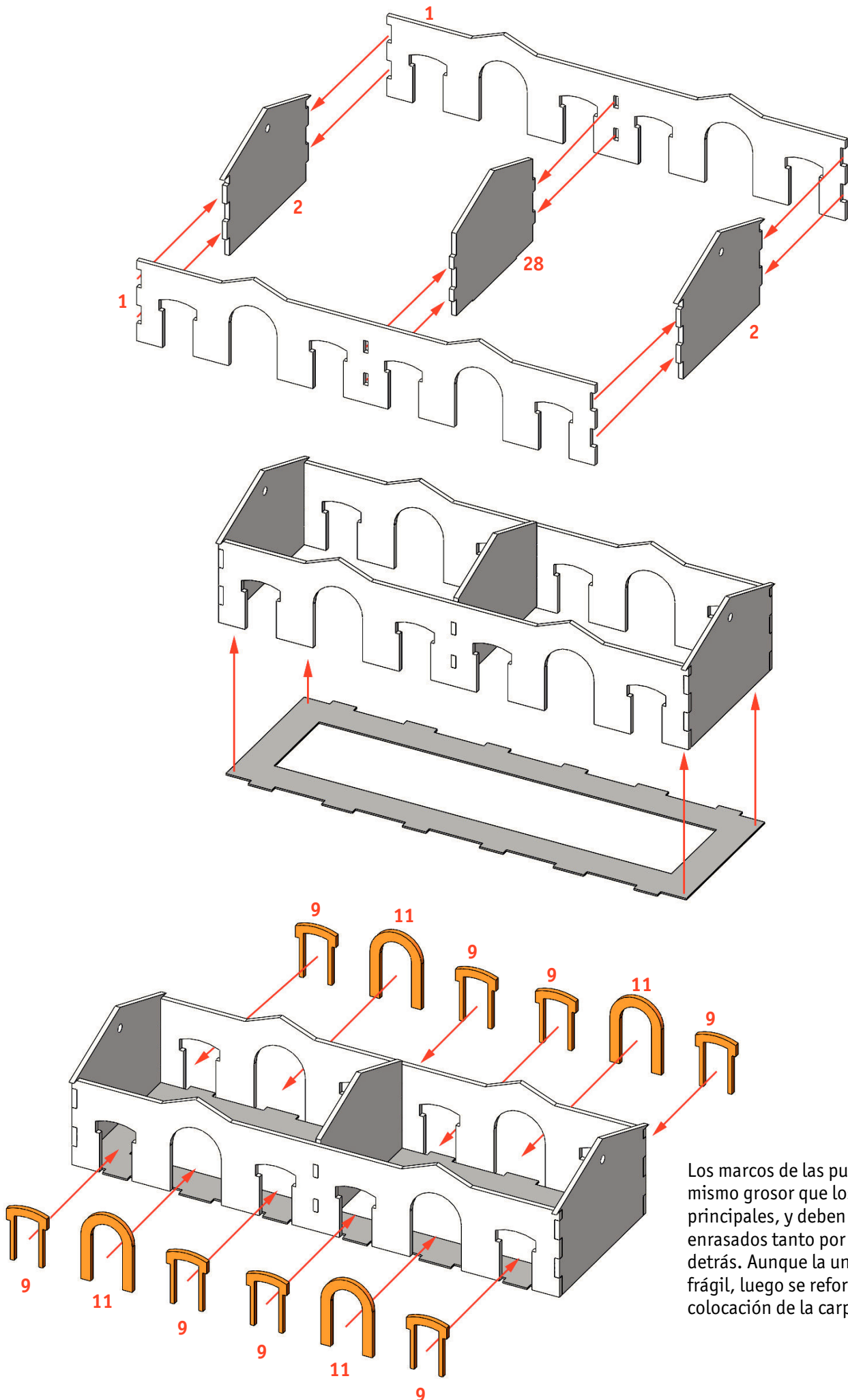

Los marcos de las puertas son del mismo grosor que los muros principales, y deben quedar enrasados tanto por delante como por detrás. Aunque la unión parezca frágil, luego se reforzará con la colocación de la carpintería.

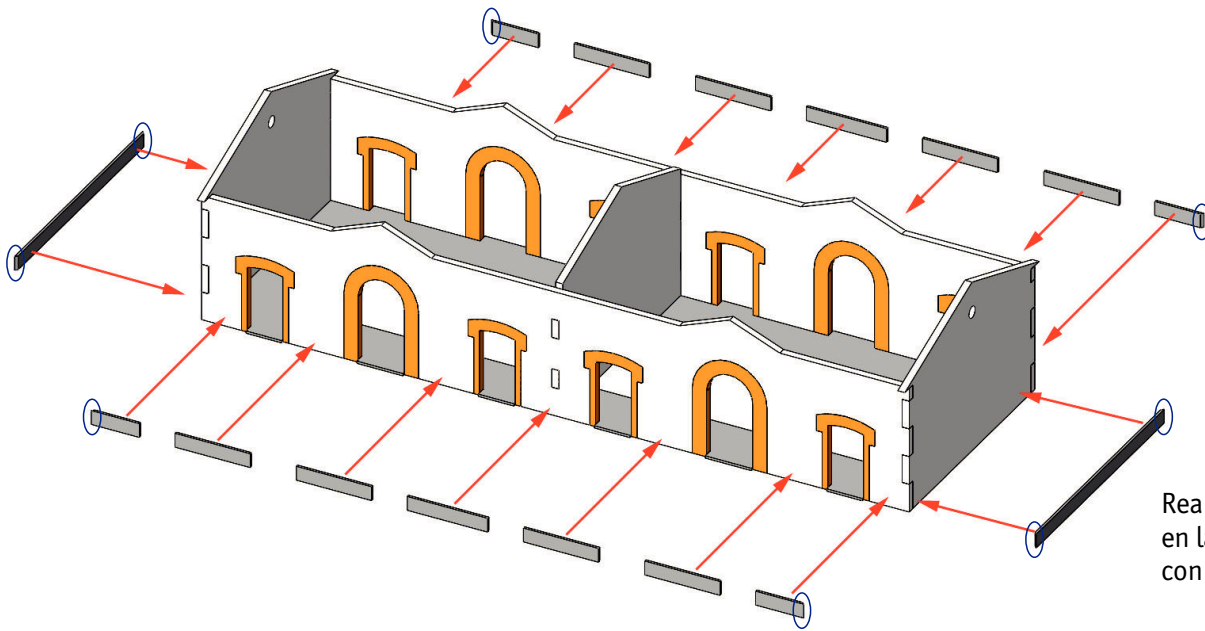

Realizar un inglete a 45° en las aristas marcadas con color azul.

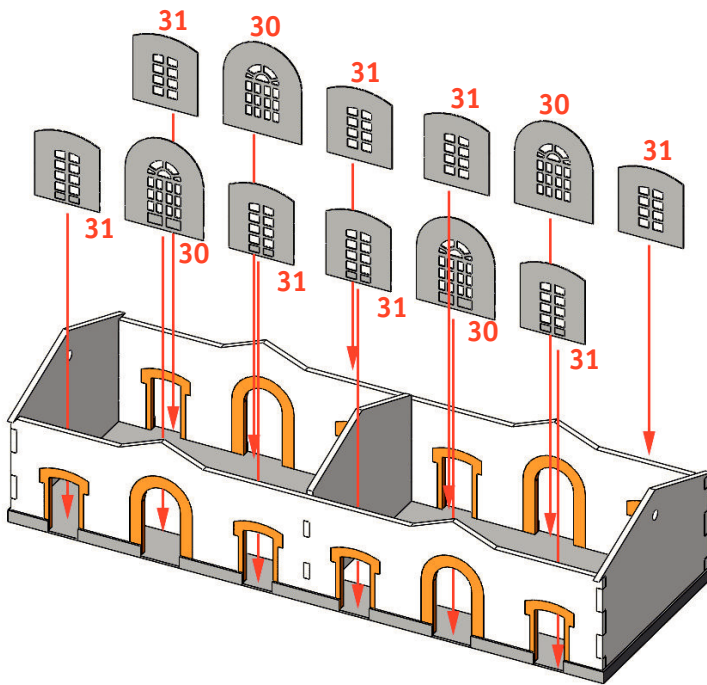

Al pegar la carpintería por el interior del edificio, pegar tanto a los muros como a los marcos de las puertas.

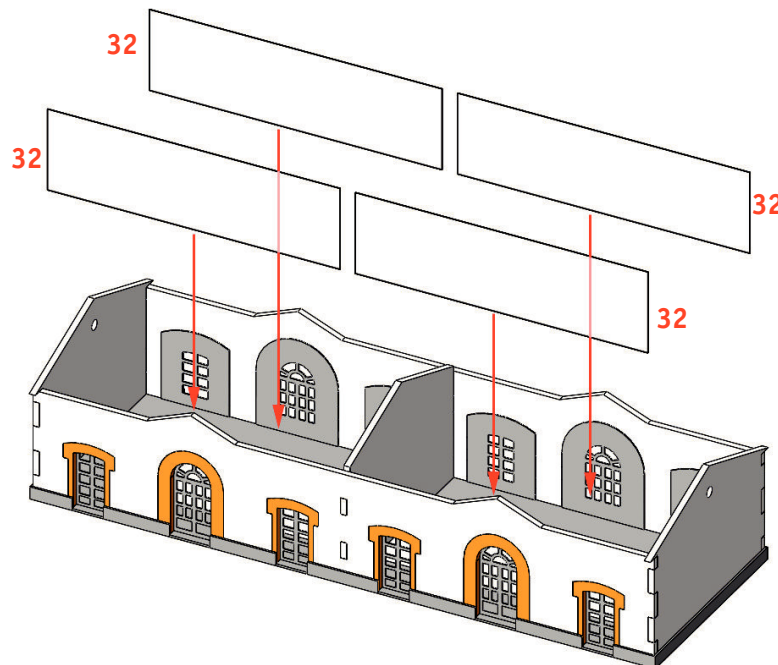



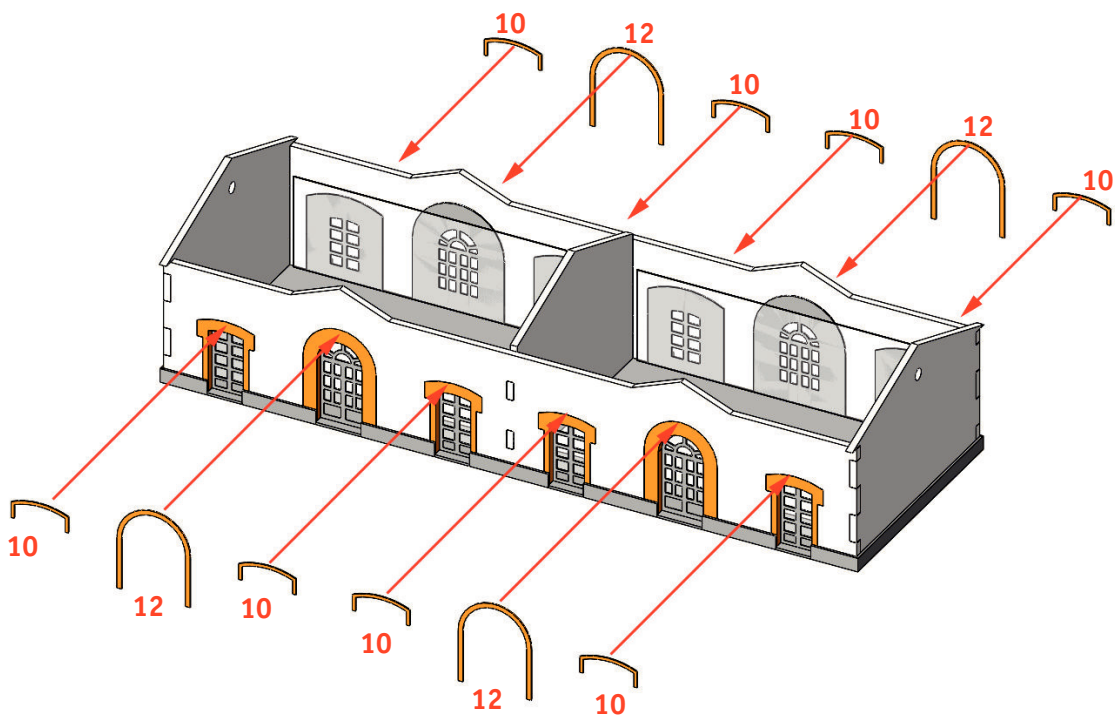

Con las piezas 10 y 12 ocultar parcialmente la unión entre marcos de puertas y muros principales.

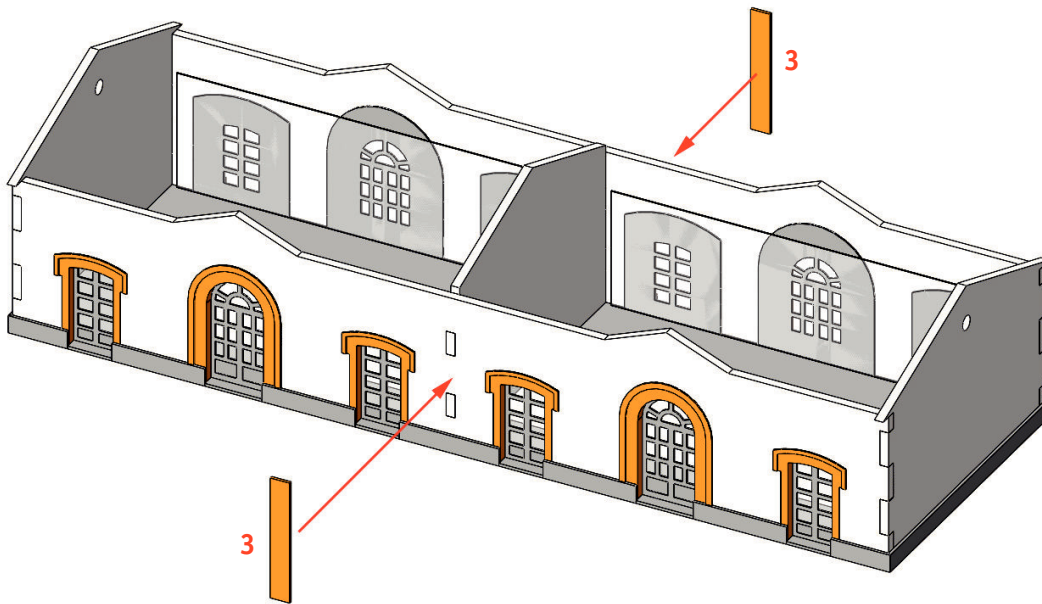

Pegar la pieza 3 completamente centrada en la fachada, apoyada sobre el zócalo y ocultando el encaje del muro interior.

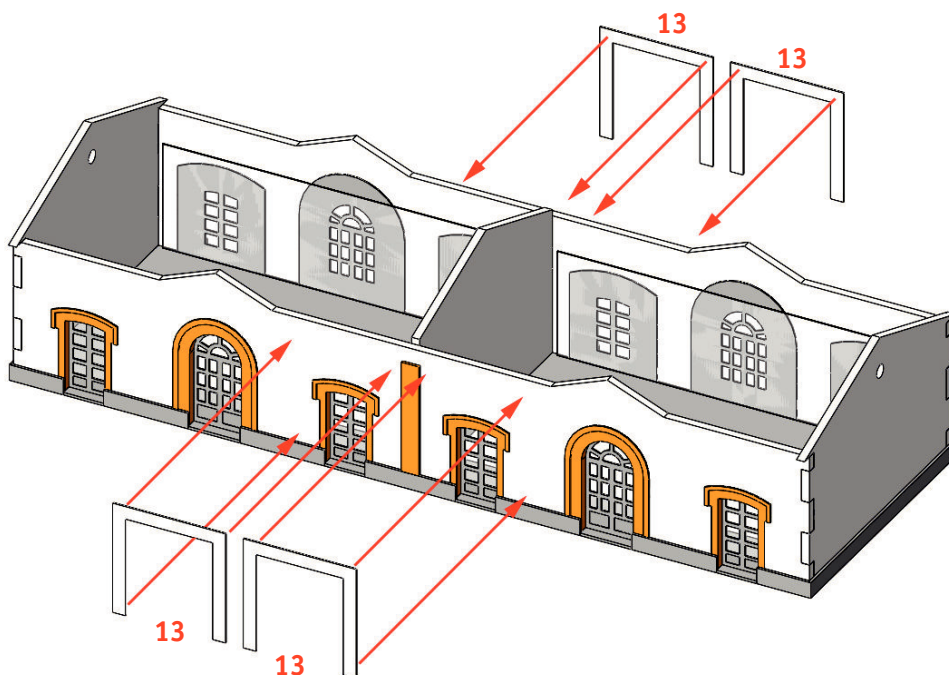

Pegar las primeras piezas num. 13 apoyadas sobre el zócalo y colindantes con el pilar pegado en el paso anterior...

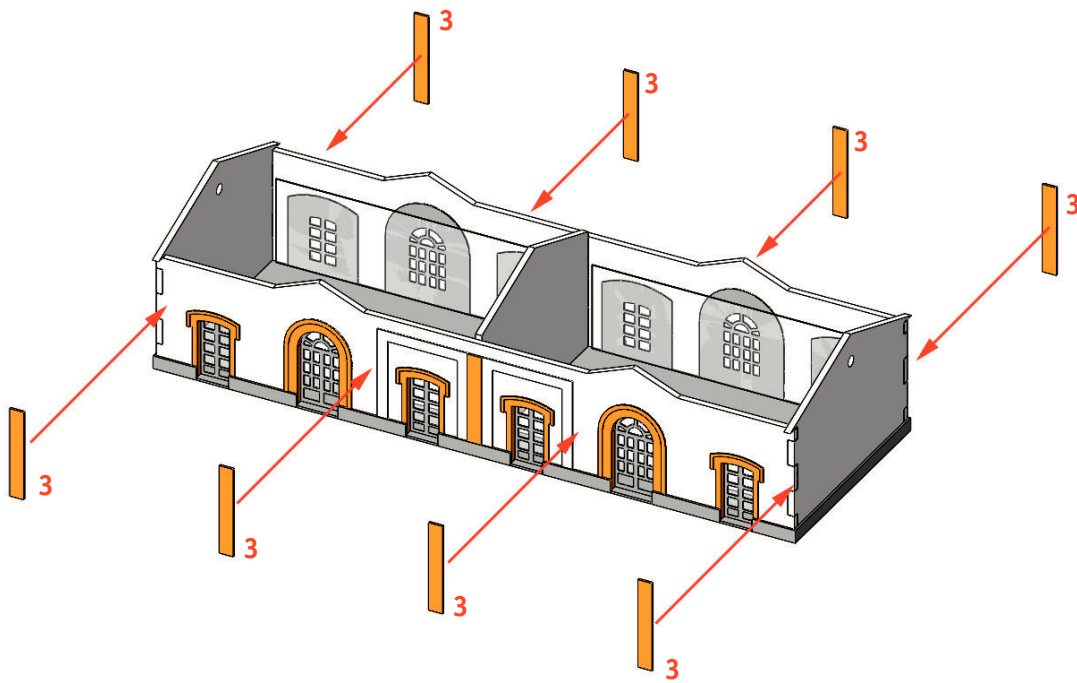

Pegar los dos pilares interiores de cada fachada ajustados sobre el marco anterior y sobre el zócalo. Los pilares de los extremos deben sobresalir 0,5 mm de la fachada para ocultar el canto de los pilares num. 4

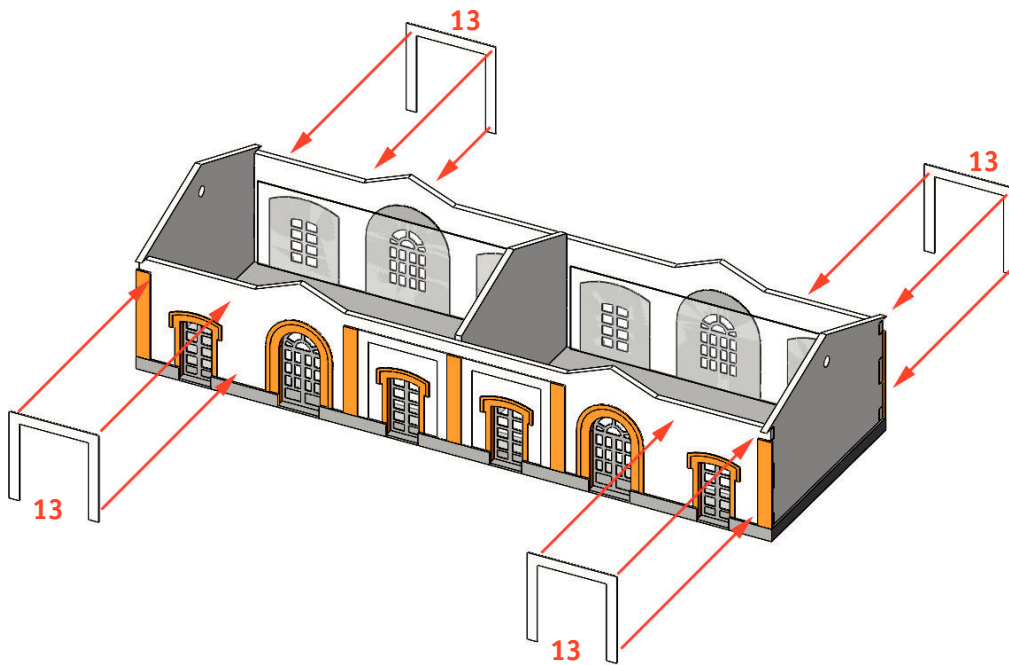

Pegar los marcos 13, colindantes con los pilares de los extremos pegados en el paso anterior

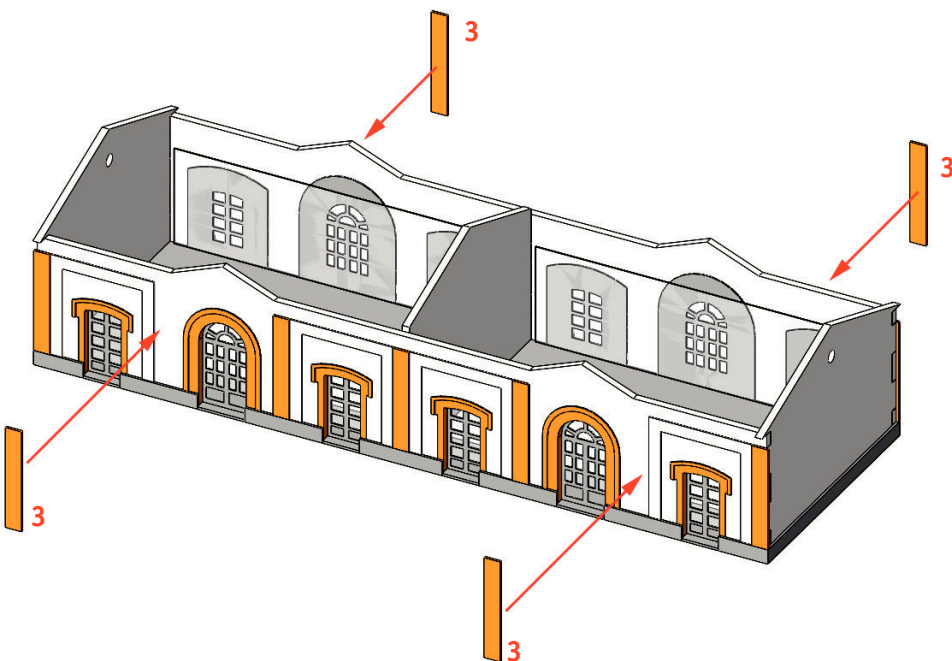

Pegar los pilares restantes (num. 3) colindantes con los marcos anteriores.

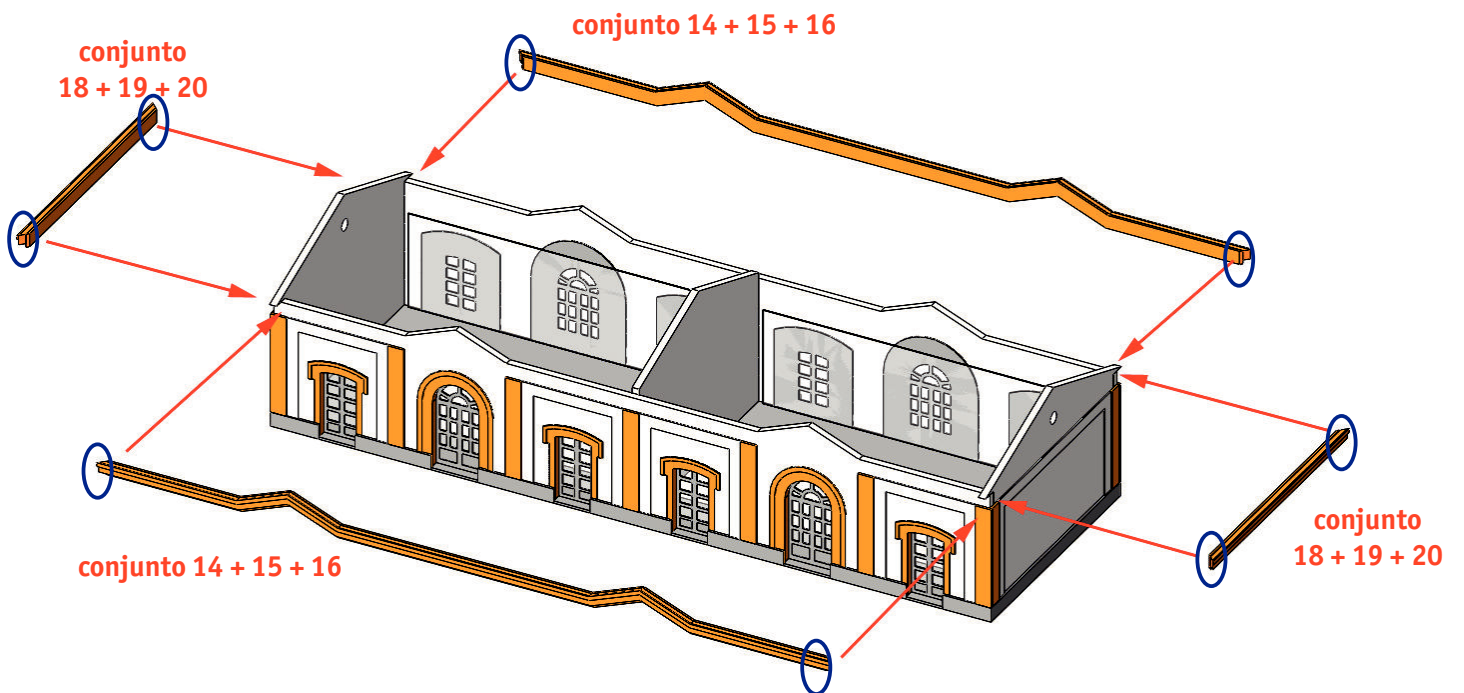
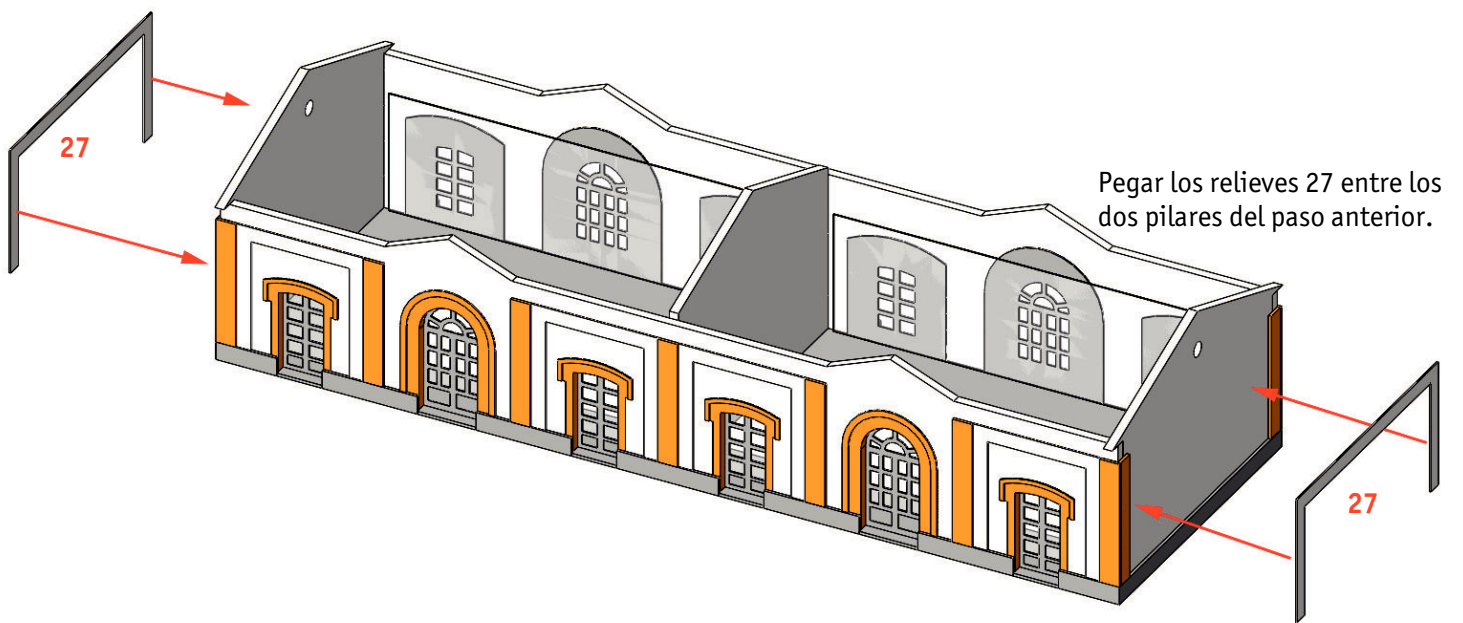
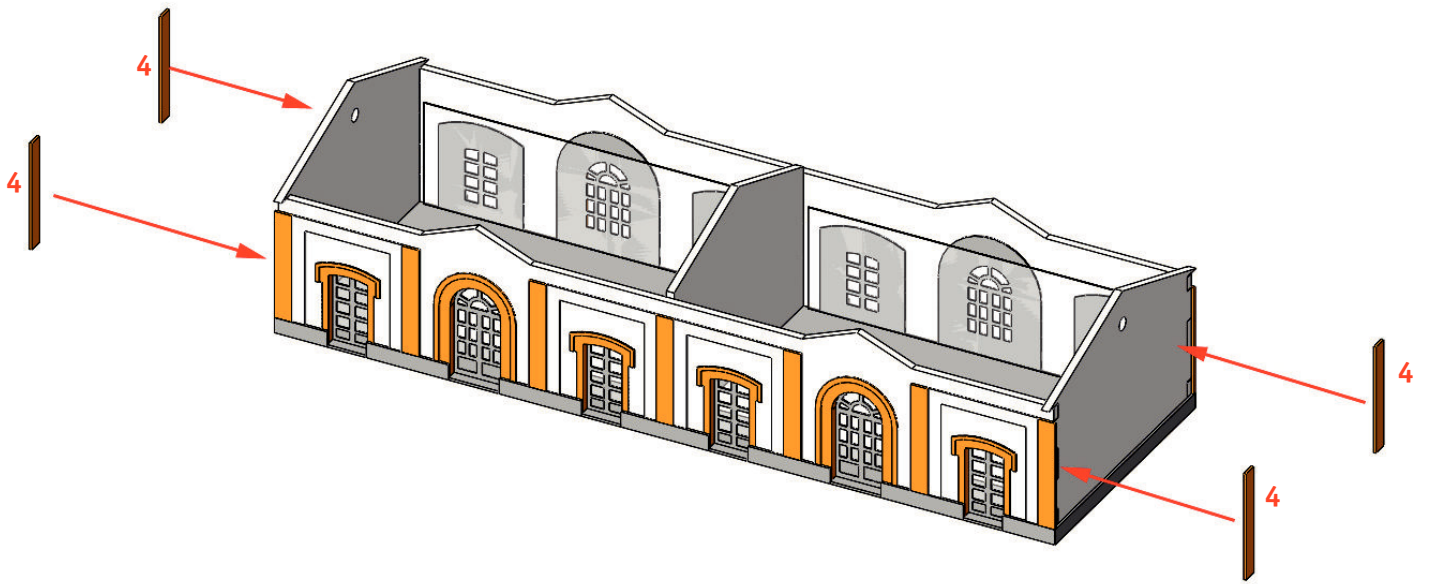

Efectuar un inglete a 45° en los extremos marcados con azul.

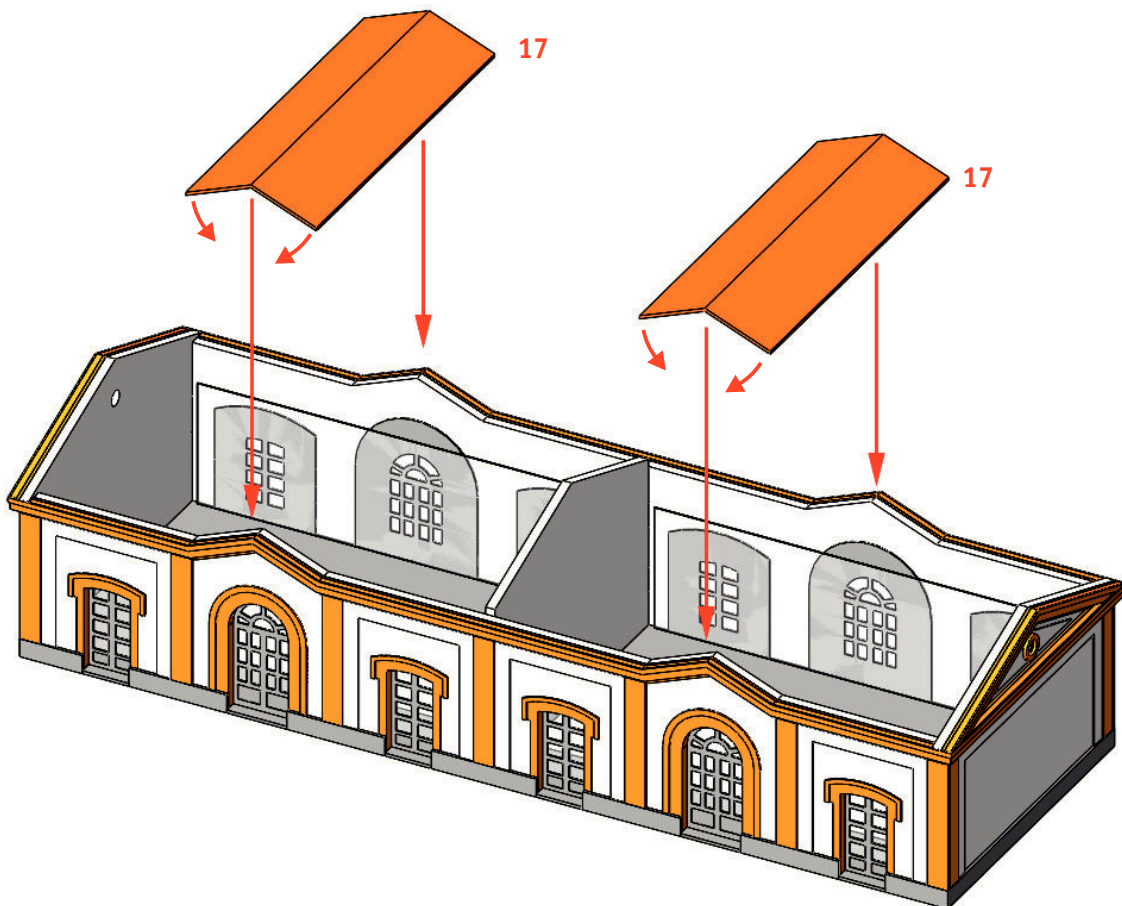
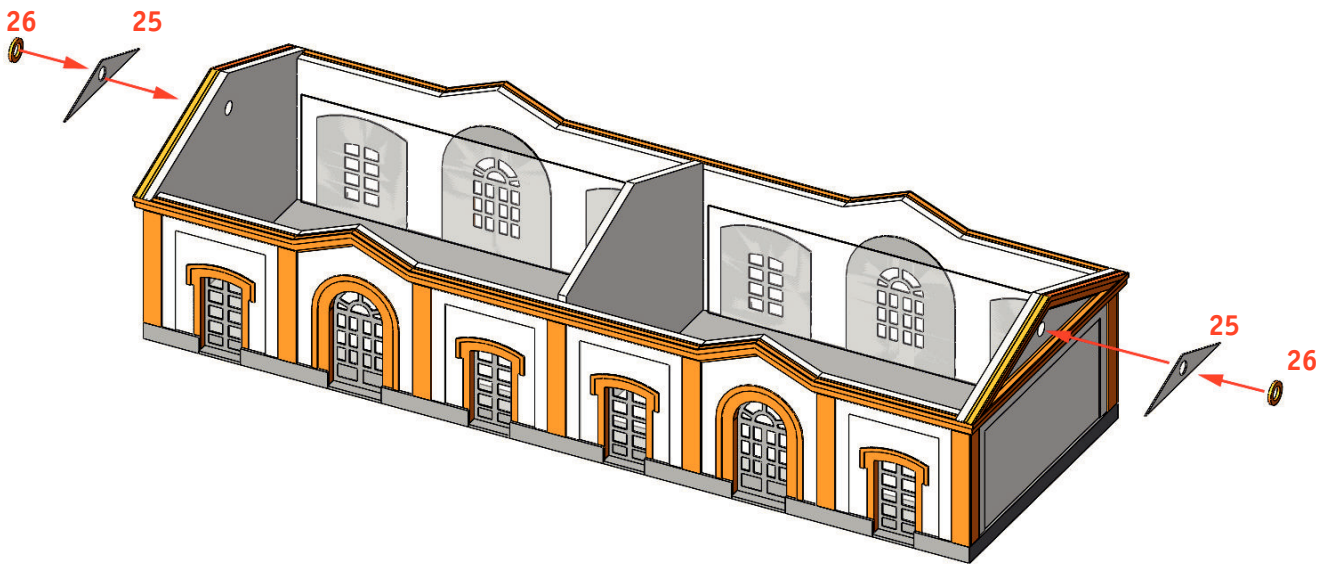
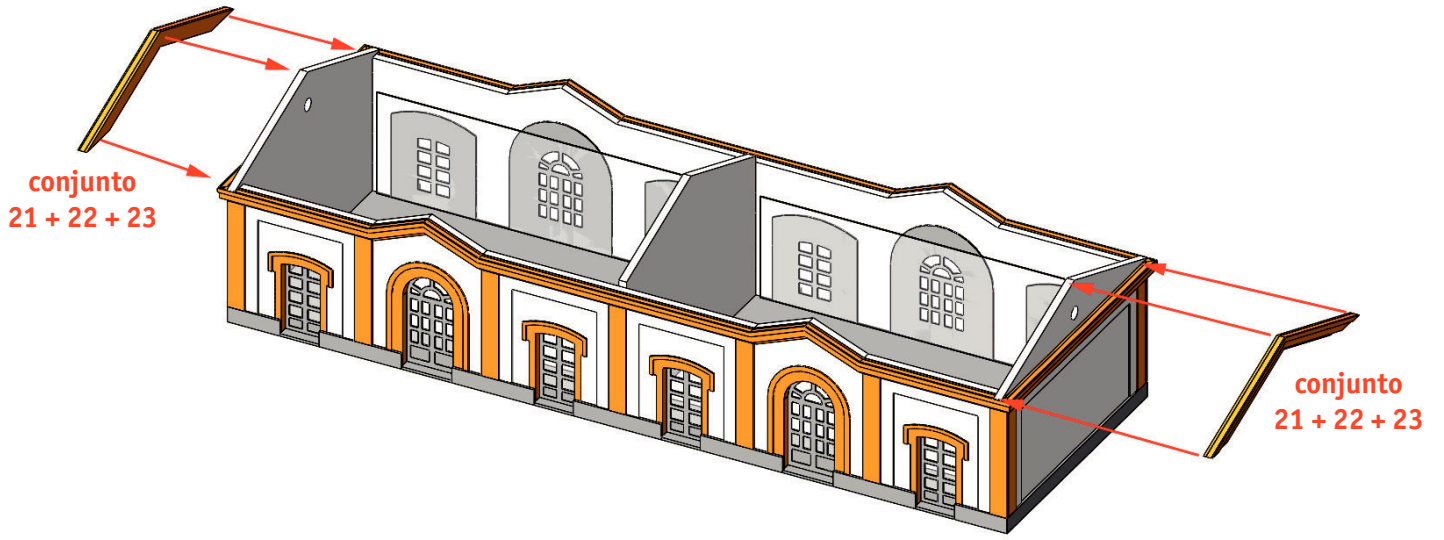

24

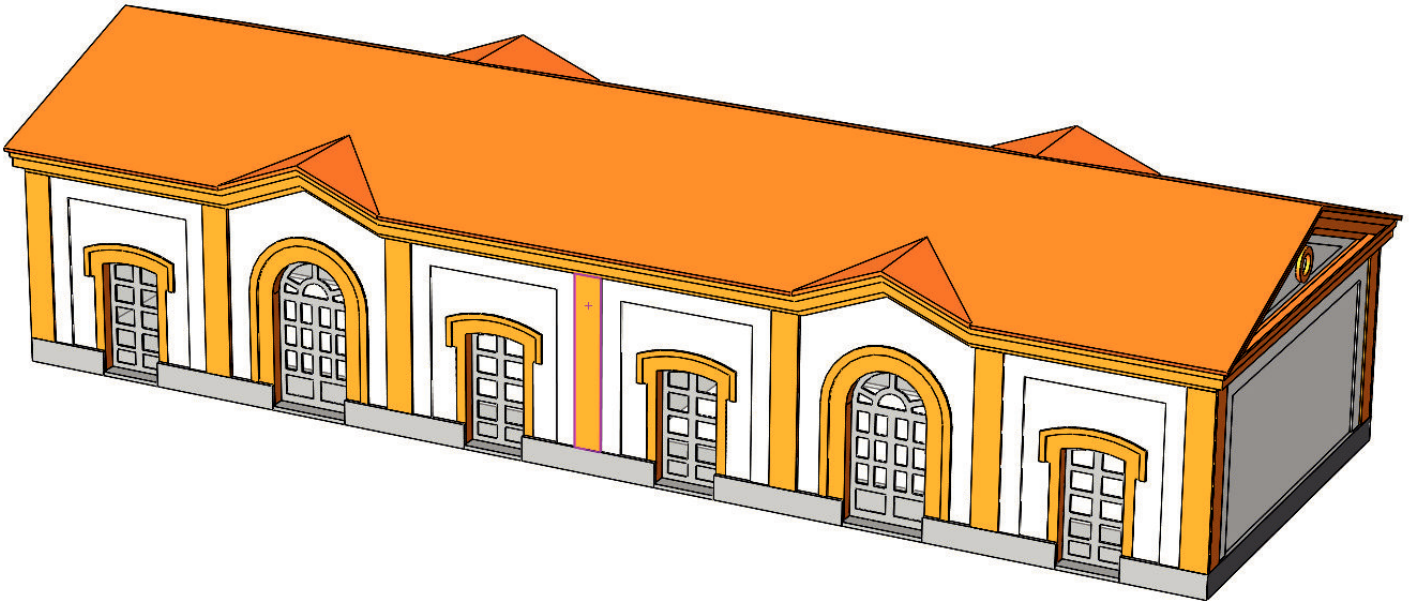
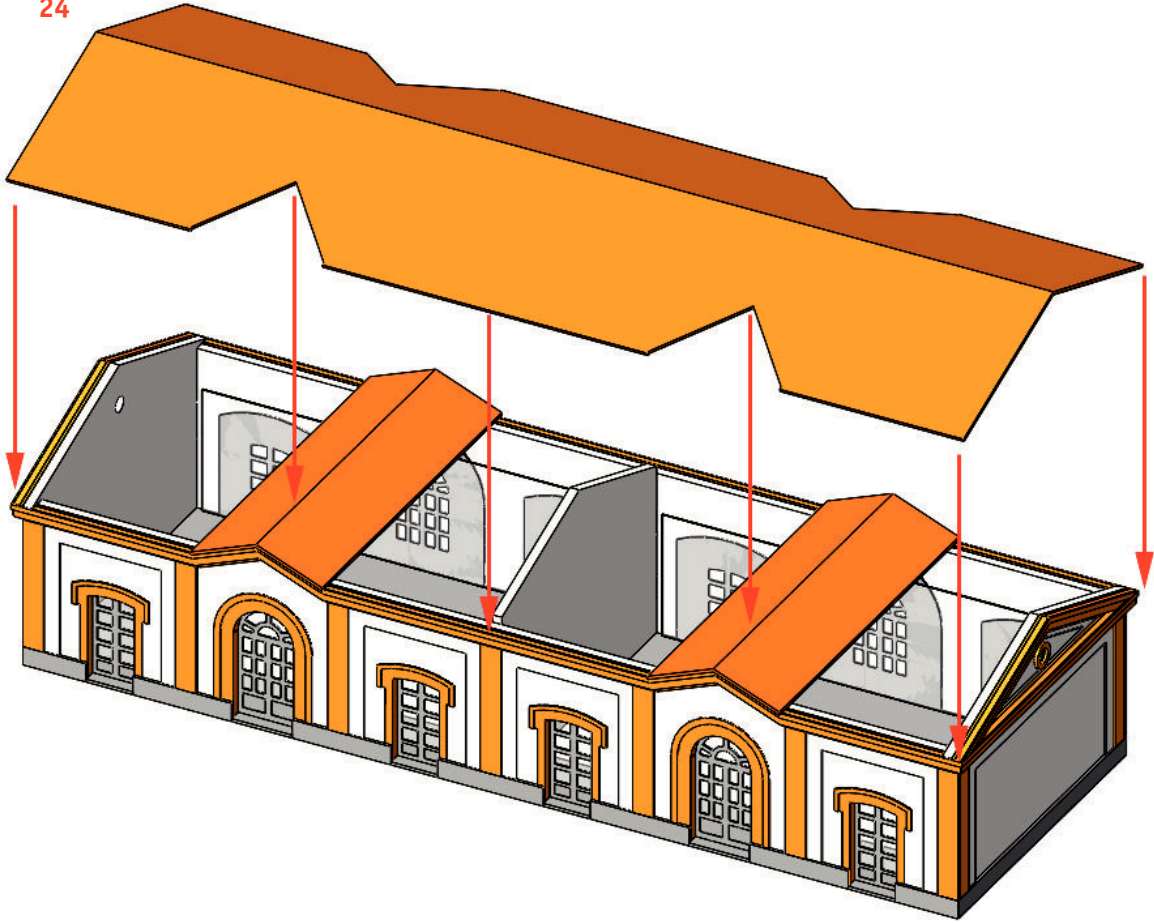

**THE END**

# N0121 Estación de Valsequillo - escala N

## Planos

