

**H-1010 La Plata Warehouse**  
**H0 scale (1:87)**

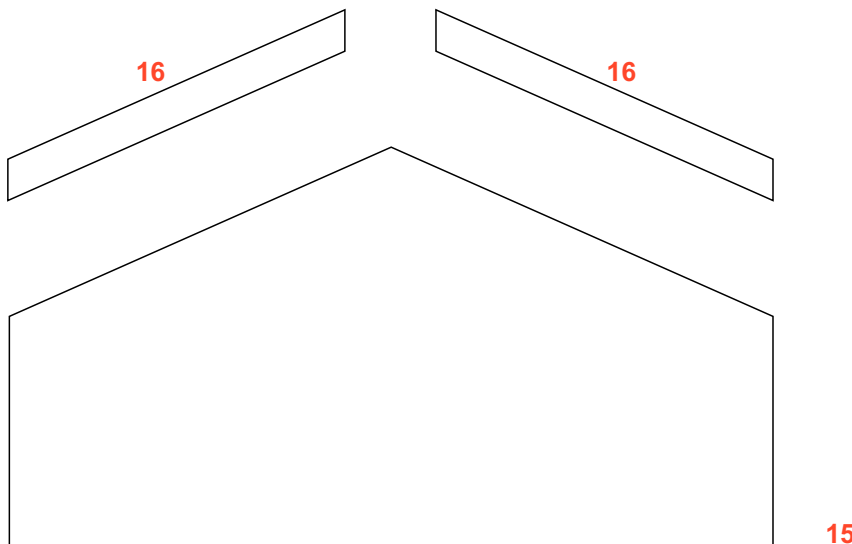

Component parts  
Assembly instructions  
Main dimensions

# H-1010 La Plata Warehouse - Component parts

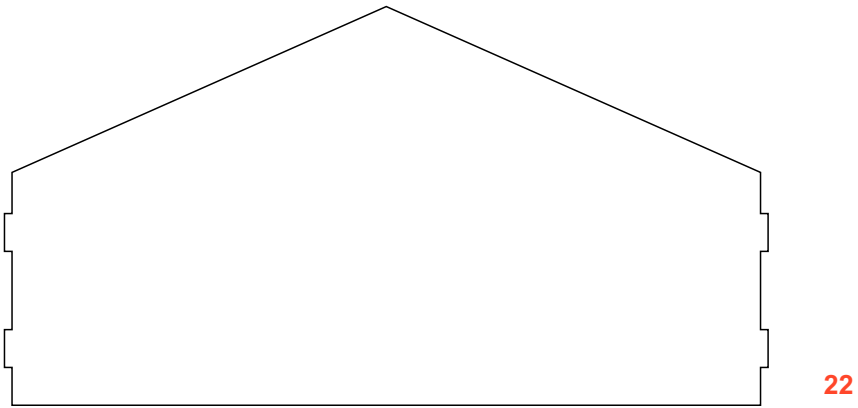
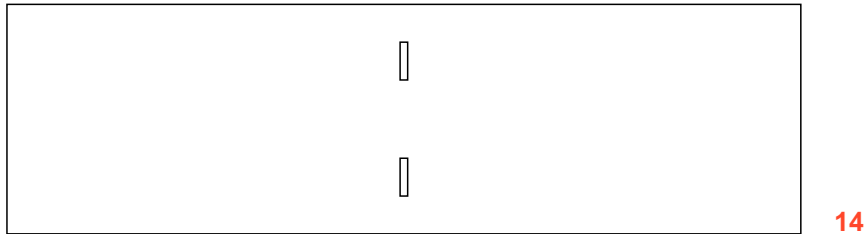
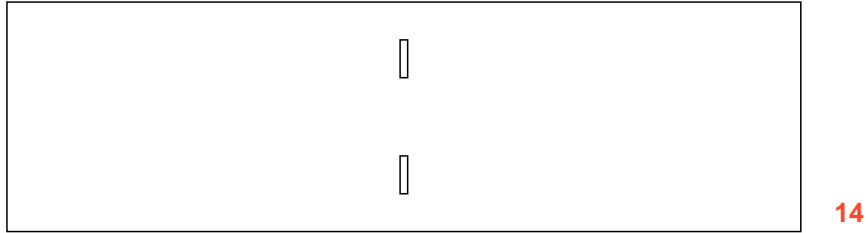
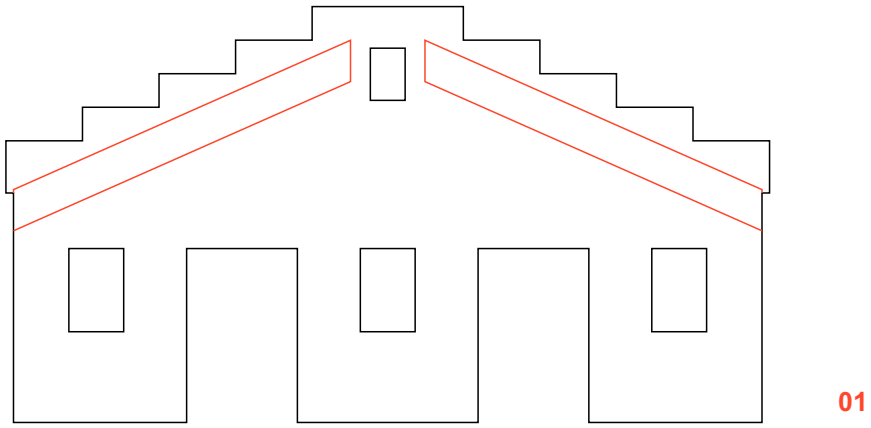

Main dimensions

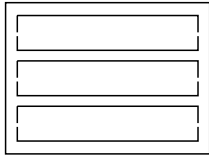

02 x3

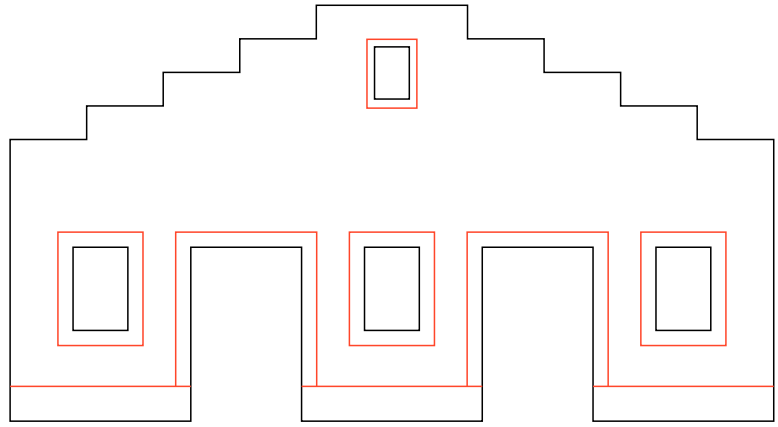

21

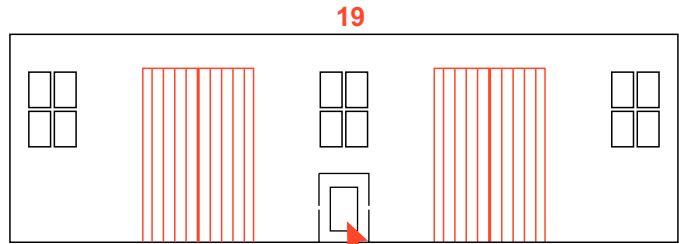
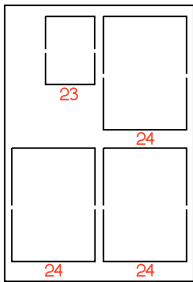

19

20

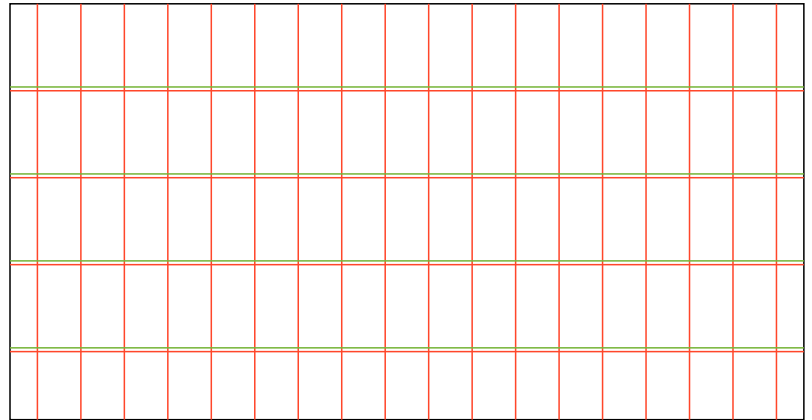
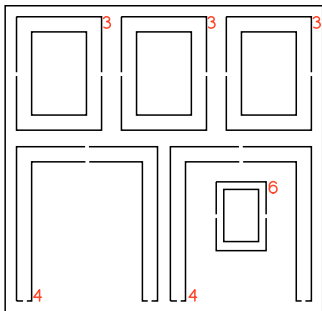
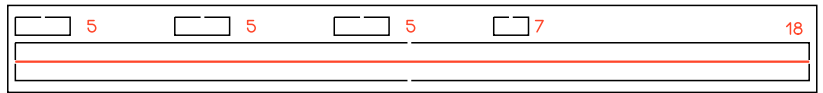

17x2

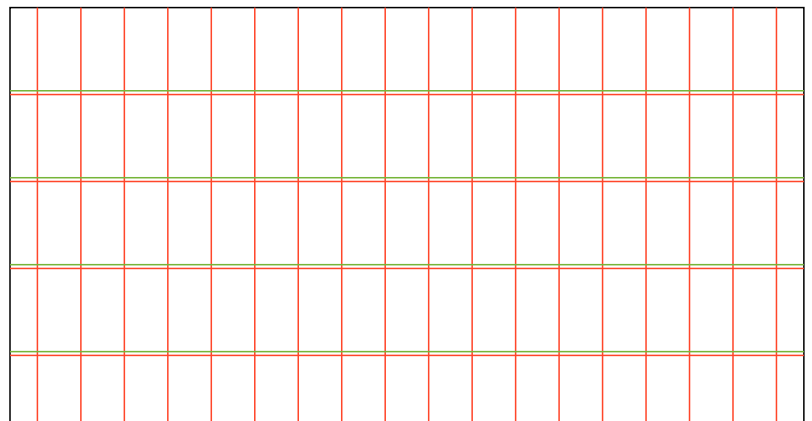
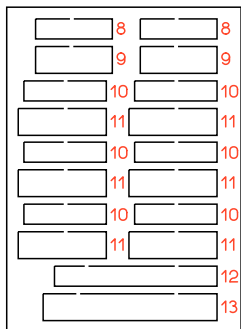

# H-1010 La Plata Warehouse - Assembly instructions

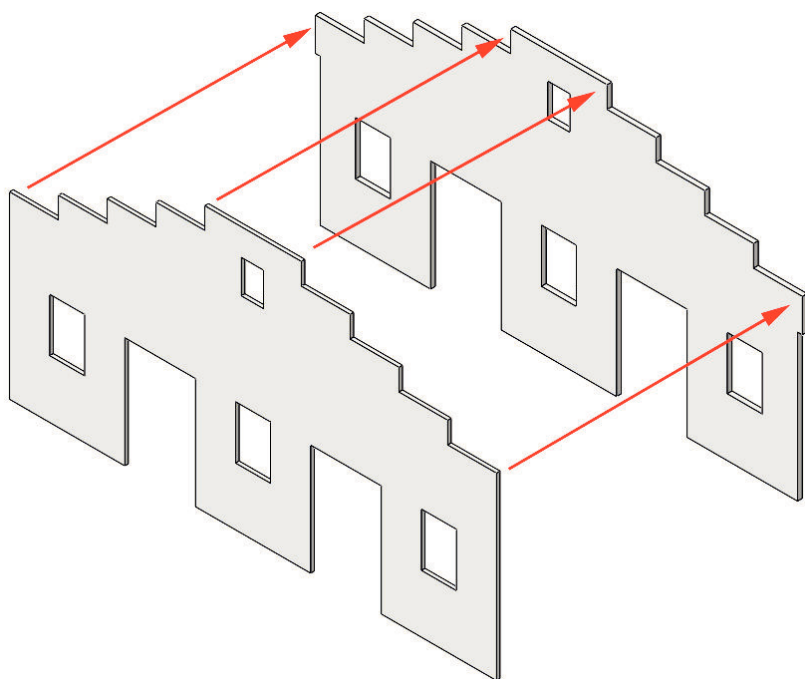

**01** Paste these two pieces with the engravings facing outwards

Pegar estas dos piezas con los grabados hacia el exterior

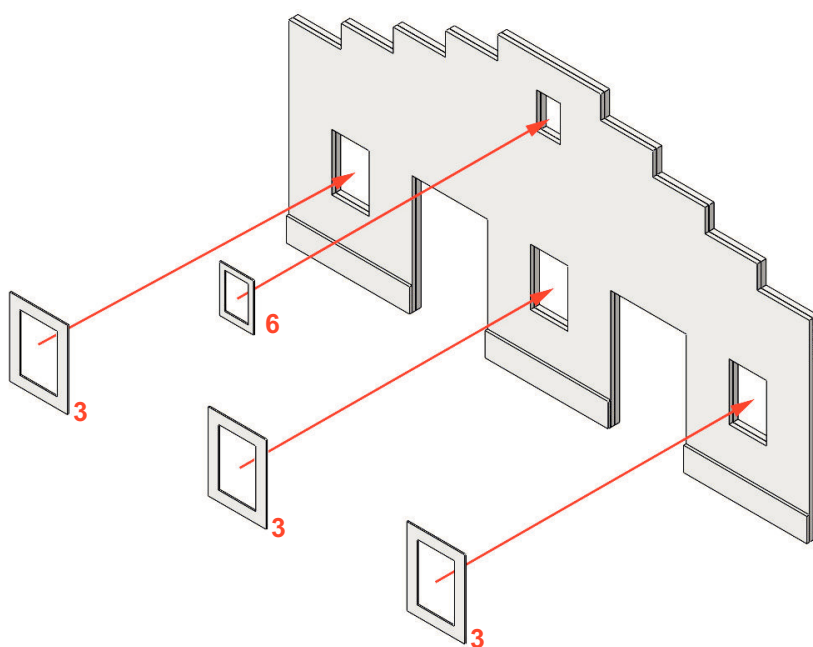
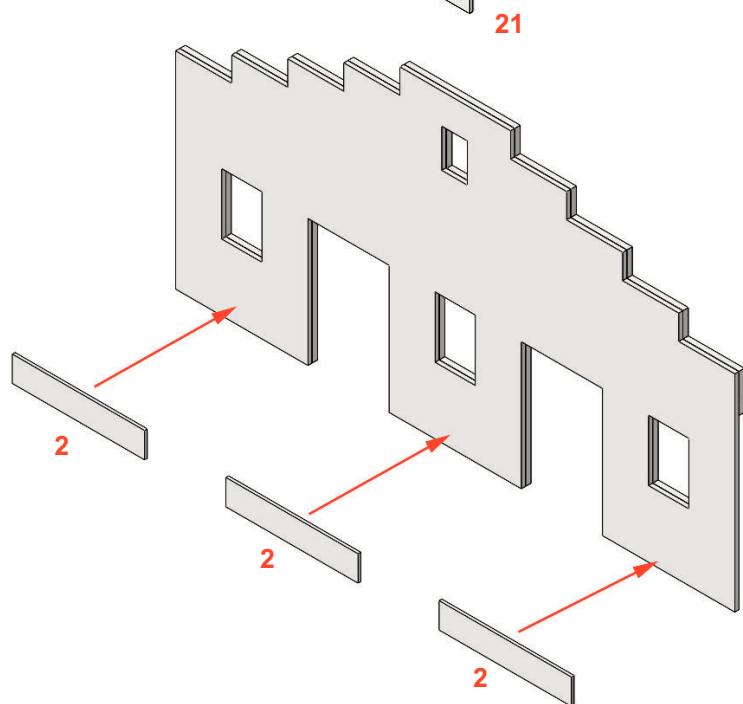

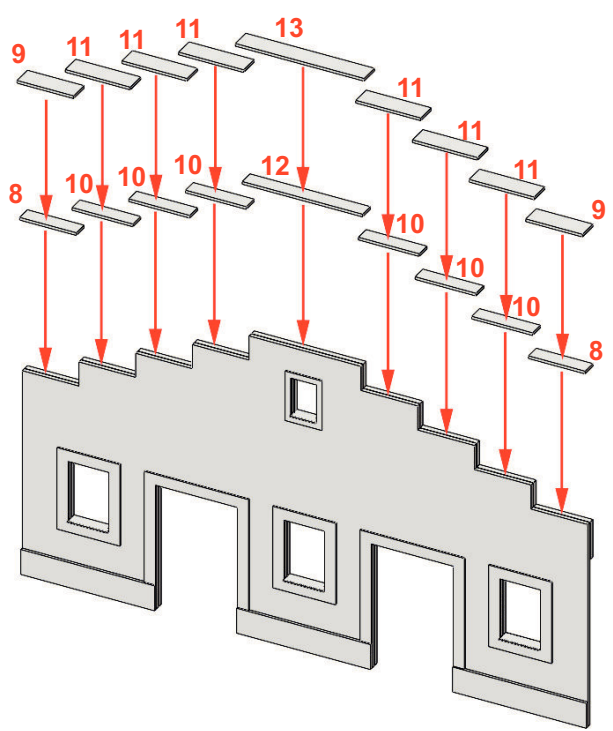
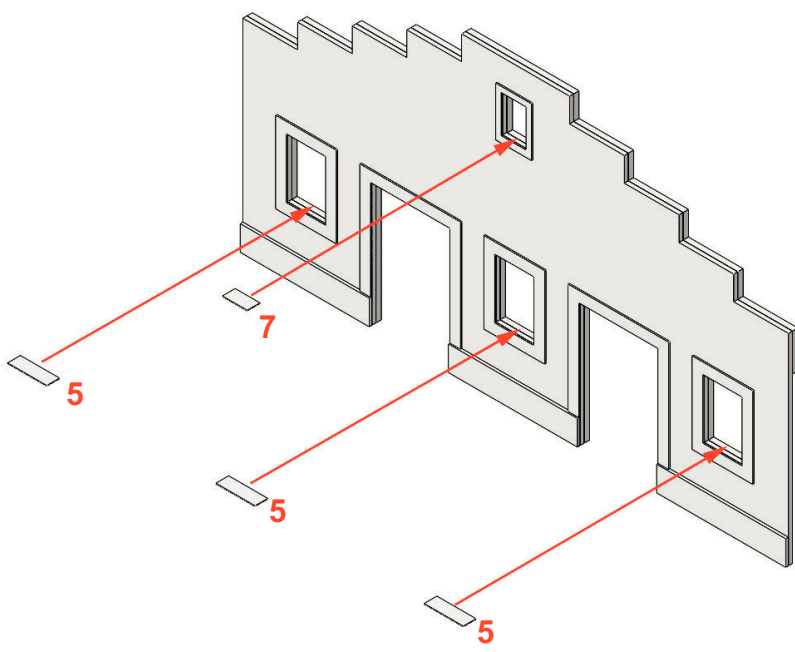
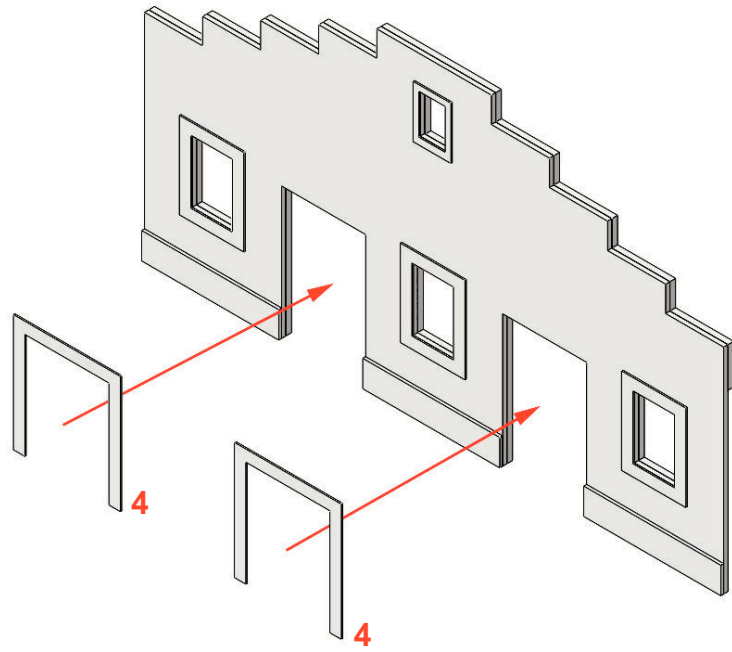

Fit these cornices to the back of the façade

Ajustar estas cornisas con la parte trasera de la fachada

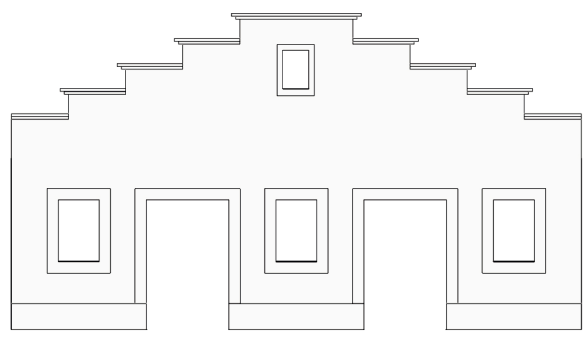

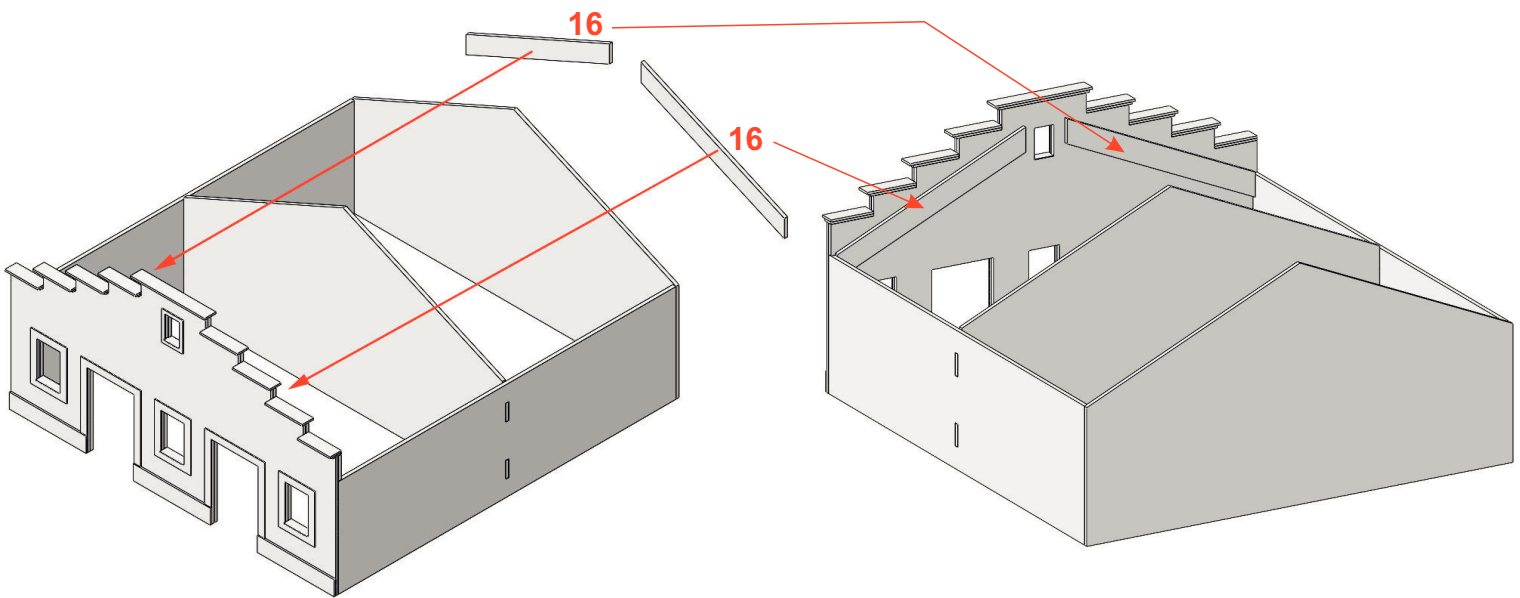
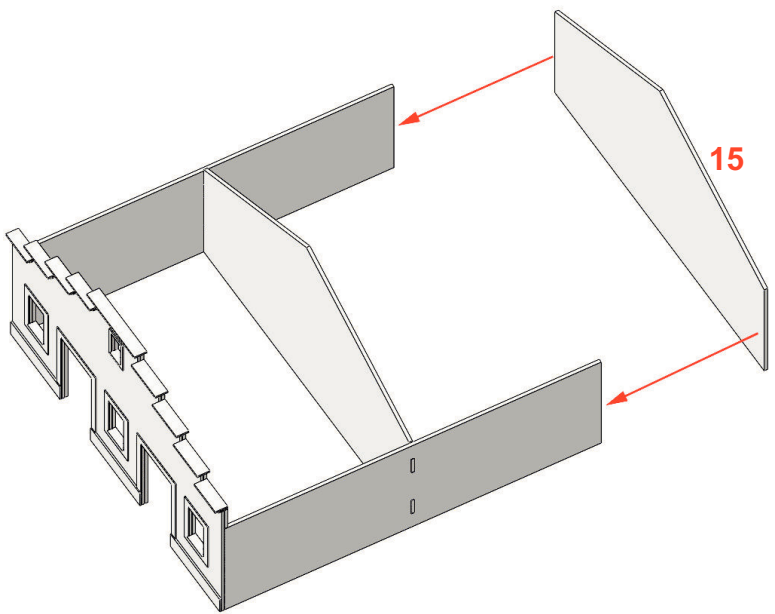
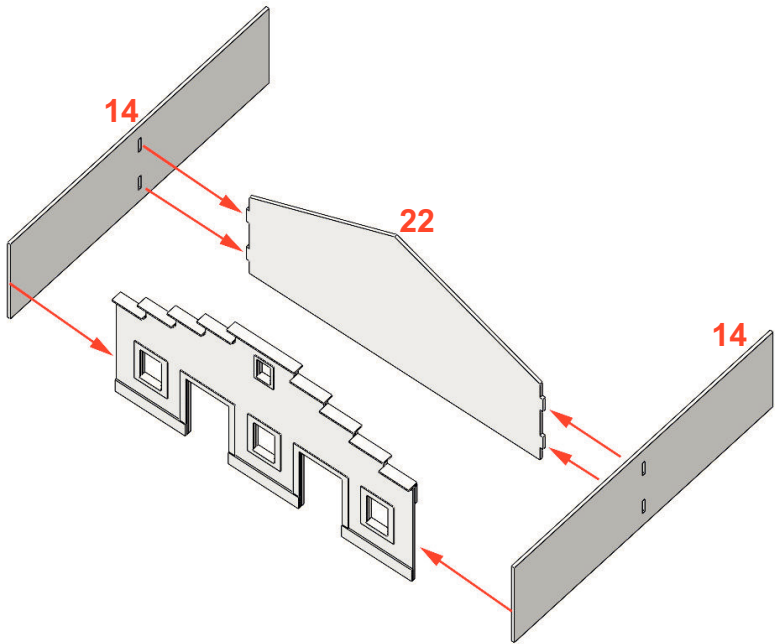

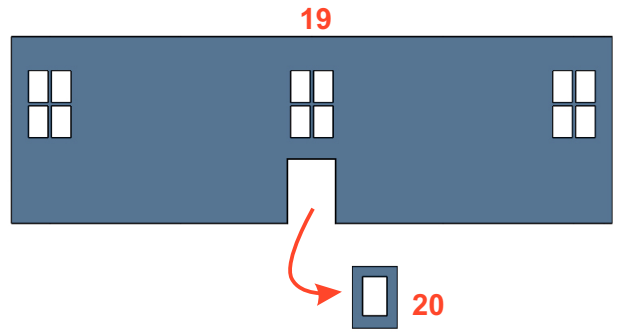
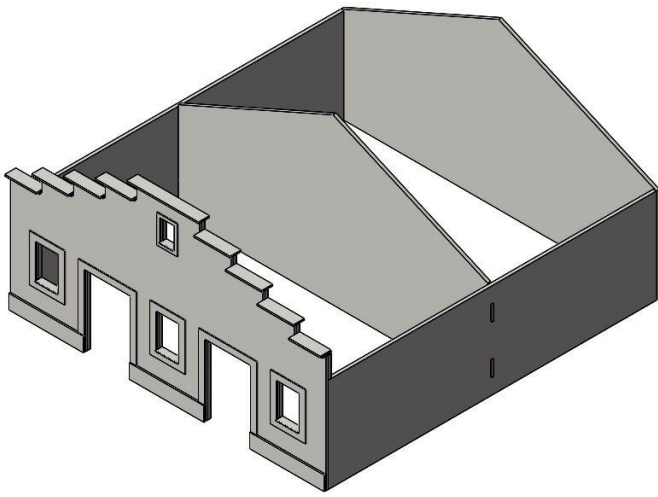

Paint the woodwork in the desired colour, before gluing it.

Pintar la carpintería del color deseado, antes de pegarla.

Now paint the whole building in the desired colour

Pintar ahora el conjunto del edificio del color deseado

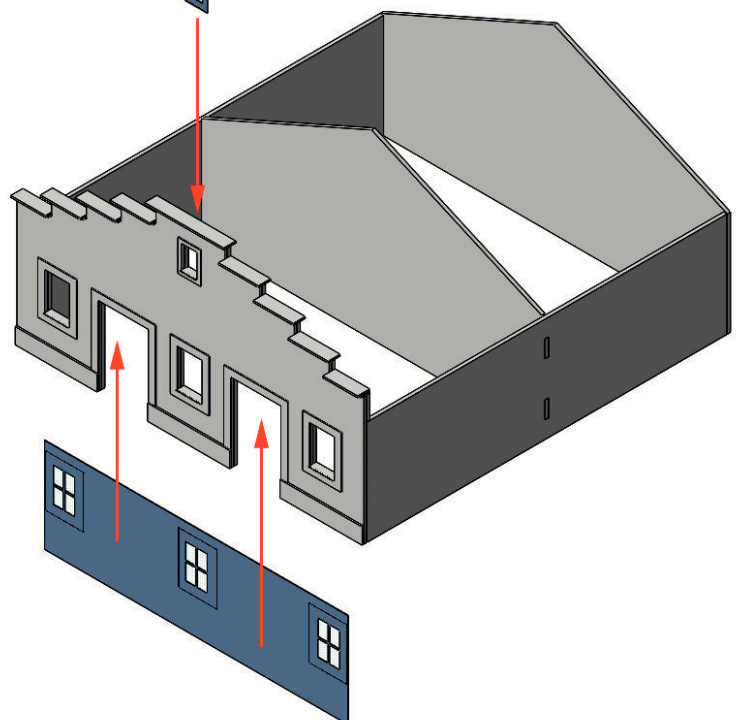
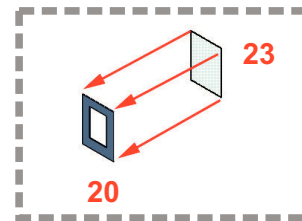
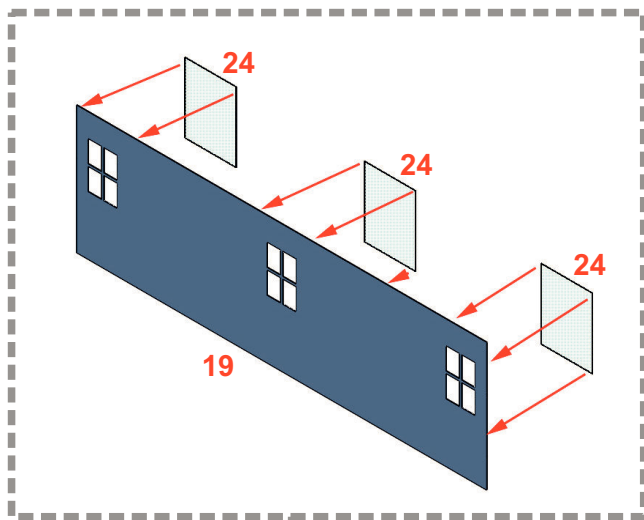

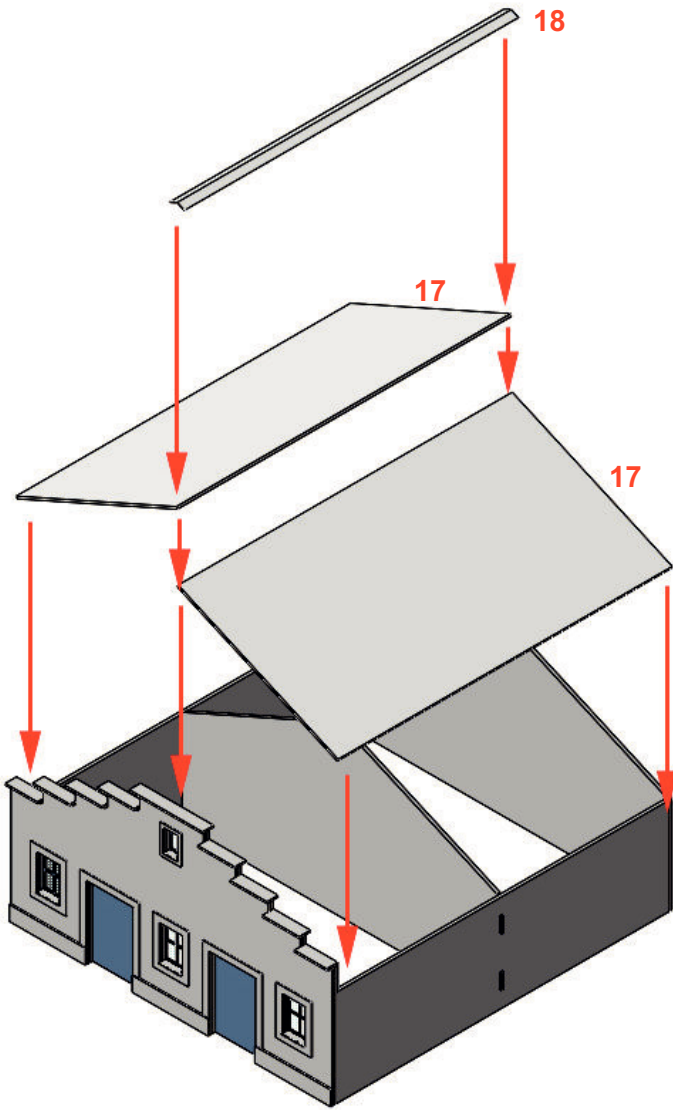

Paint the three pieces of the roof in the same colour before gluing

Pintar las tres piezas del techo del mismo color antes de pegar

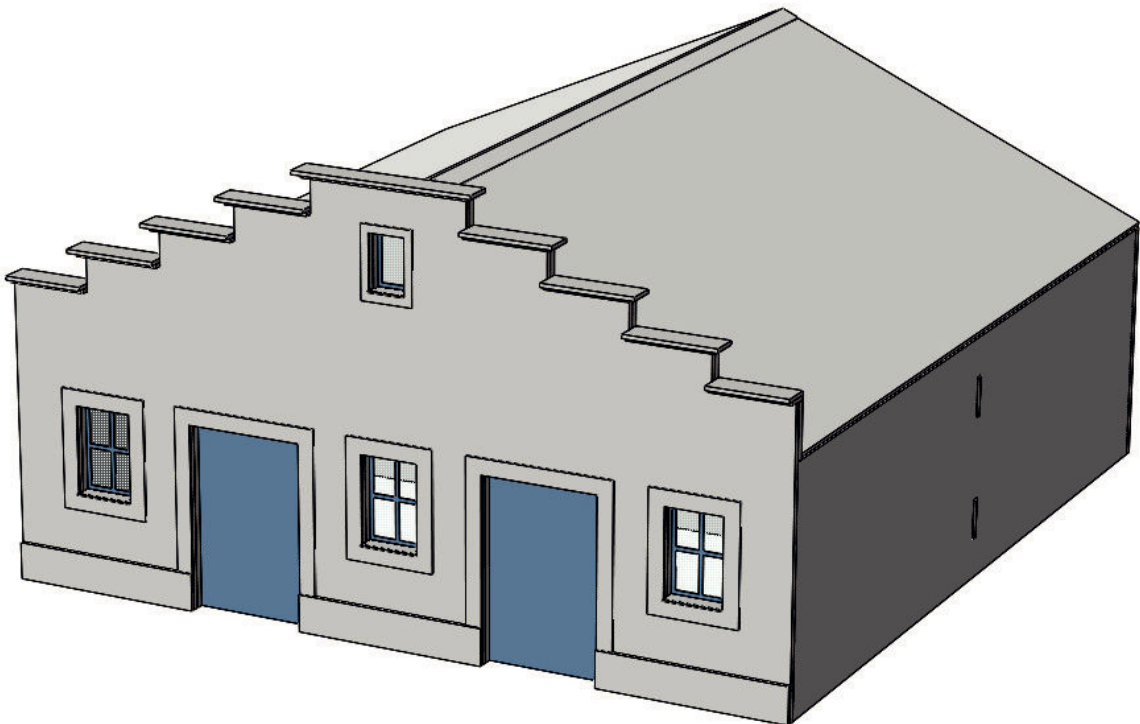



# H-1010 La Plata Warehouse - Main dimensions

